

Mar. 2011



SERVICE MANUAL ADDENDUM

IC-FR5000 IC-FR5100

CONTENTS

PARTS LIST	1
BOARD LAYOUTS	9
VOLTAGE DIAGRAM	11

PARTS LIST

[MAIN UNIT]

Table with 5 columns: REF NO., PARTS NO., DESCRIPTION, M., H/V LOCATION. Lists various components and their locations for the main unit.

M.=Mounted side (T: Mounted on the Top side, B: Mounted on the Bottom side) S.=Surface mount

[MAIN UNIT]

Table with 5 columns: REF NO., PARTS NO., DESCRIPTION, M., H/V LOCATION. Lists various components and their locations for the main unit.

M.=Mounted side (T: Mounted on the Top side, B: Mounted on the Bottom side) S.=Surface mount

[MAIN UNIT]

REF NO.	PARTS NO.	DESCRIPTION	M.	H/V LOCATION
W2	7030012290	JUM RDS2TOR0		
W4	8900017520	CAB OPC-1783		
EP1	6910015370	S.BEA ACZ1005Y-102-T	B	129.1/48.4
EP2	6910015370	S.BEA ACZ1005Y-102-T	B	115.5/45.6
EP3	6910015370	S.BEA ACZ1005Y-102-T	B	32.4/81.6
EP4	6910016330	S.BEA MMZ1005S 601CT-S	B	30.5/60.6
EP5	6910015370	S.BEA ACZ1005Y-102-T	B	39.0/74.3
EP6	6910015370	S.BEA ACZ1005Y-102-T	T	38.5/108.3
EP7	6910016330	S.BEA MMZ1005S 601CT-S	B	40.7/36.7
EP8	6910015370	S.BEA ACZ1005Y-102-T	B	95.4/49.0
EP9	6910016330	S.BEA MMZ1005S 601CT-S	T	48.9/39.4
EP10	6910011560	BEA HF70BB4.5X5X1.6		
EP13	6910011330	TER OT-009 M3		
EP14	6910011330	TER OT-009 M3		
EP16	6910018460	S.BEA MMZ1005Y102C-T	T	64.1/105.0
EP17	6910018460	S.BEA MMZ1005Y102C-T	T	65.1/105.0
EP18	6910018460	S.BEA MMZ1005Y102C-T	T	66.1/105.0
EP19	6910018460	S.BEA MMZ1005Y102C-T	T	66.1/106.8
EP20	6910018460	S.BEA MMZ1005Y102C-T	T	62.8/98.7
EP21	6910018460	S.BEA MMZ1005Y102C-T	T	62.8/99.6
EP22	6910018460	S.BEA MMZ1005Y102C-T	T	74.1/105.0
EP23	6910018460	S.BEA MMZ1005Y102C-T	T	73.2/105.0
EP24	6910018460	S.BEA MMZ1005Y102C-T	T	72.3/105.0
EP25	6910018460	S.BEA MMZ1005Y102C-T	T	71.1/105.0
EP26	6910018460	S.BEA MMZ1005Y102C-T	T	72.4/99.0
EP27	6910018460	S.BEA MMZ1005Y102C-T	T	68.2/99.1
EP28	6910018460	S.BEA MMZ1005Y102C-T	T	67.3/99.1
EP29	6910018460	S.BEA MMZ1005Y102C-T	T	65.8/99.1
EP30	6910018460	S.BEA MMZ1005Y102C-T	T	74.3/99.0
EP31	6910018460	S.BEA MMZ1005Y102C-T	T	70.6/98.2

[FRONT UNIT]

REF NO.	PARTS NO.	DESCRIPTION	M.	H/V LOCATION
IC500	1130009121	S.IC S1D15206F00A200	B	69.5/36.0
IC501	1110005771	S.IC S-80942CNMC-G9CT2G	B	105.3/24.1
IC502	1140014582	S.IC UPD78F1153GK(R)-GAK-AX (3063C-3)	B	101.4/38.8
IC503	1110005350	S.IC NJM2870F05-TE1-#FZZB	B	47.3/30.5
IC506	1140013200	S.IC CD4053BPWVR	B	39.1/31.7
IC508	1110002751	S.IC TA75S01F(TE85RF)	B	143.0/18.1
IC509	1110006770	S.IC TDA8547TS/N	B	28.5/55.8
Q500	1590001050	S.TRA DTC114TUA T106	B	148.5/41.4
Q501	1590001050	S.TRA DTC114TUA T106	B	161.8/34.6
Q502	1590001050	S.TRA DTC114TUA T106	B	161.9/41.4
Q503	1590001050	S.TRA DTC114TUA T106	B	148.5/34.6
Q504	1590001050	S.TRA DTC114TUA T106	B	91.4/45.6
Q506	1590001190	S.TRA XP6501-(TX).AB	B	33.0/48.2
Q508	1520000460	S.TRA 2SB1132 T100 R	B	36.9/52.7
Q510	1590001050	S.TRA DTC114TUA T106	B	152.9/53.3
Q511	1590001050	S.TRA DTC114TUA T106	B	166.3/53.0
Q513	1590001060	S.TRA DTA114TUA T106	B	168.8/53.0
Q514	1590001060	S.TRA DTA114TUA T106	B	160.1/49.6
Q515	1590001060	S.TRA DTA114TUA T106	B	155.4/53.3
Q516	1590001060	S.TRA DTA114TUA T106	B	145.4/49.9
Q517	1590001050	S.TRA DTC114TUA T106	B	160.1/49.9
Q518	1590001050	S.TRA DTC114TUA T106	B	145.4/47.1
D503	1790001261	S.DIO MA2S077G0L	B	112.3/33.9
D504	1790001251	S.DIO MA2S1110GL	B	95.1/45.9
D505	1790001450	S.DIO RB160L-40 TE-25	B	41.8/26.6
D506	1790001450	S.DIO RB160L-40 TE-25	B	63.2/6.6
D507	1790000951	S.ZEN MAZ8056GML	B	160.8/29.9
D508	1750000370	S.DIO DA221 TL	B	153.2/27.7
D509	1750000370	S.DIO DA221 TL	B	166.4/28.1
D510	1790001251	S.DIO MA2S1110GL	B	43.2/51.6
D511	1790001251	S.DIO MA2S1110GL	B	115.9/45.0
D512	1790001251	S.DIO MA2S1110GL	B	65.3/10.2
D513	1790001251	S.DIO MA2S1110GL	B	36.3/24.4
X501	6050012680	S.XTA CR-858(SMD-49/18.432 MHz) <JJE>	B	113.1/28.2
L500	6200002861	S.COI NLV25T-4R7J	B	106.1/17.9
L501	6200003640	S.COI MLF1608E 100K-T	B	161.6/17.9
L502	6200002861	S.COI NLV25T-4R7J	B	86.0/39.4
R500	7030003810	S.RES ERJ3GEYJ 125 V (1.2M)	B	83.6/43.7
R501	7030003810	S.RES ERJ3GEYJ 125 V (1.2M)	B	87.4/47.5
R506	7030007290	S.RES ERJ2GEJ 222 X (2.2K)	B	157.8/36.3
R507	7030007300	S.RES ERJ2GEJ 332 X (3.3K)	B	167.9/44.3
R508	7030007290	S.RES ERJ2GEJ 222 X (2.2K)	B	167.9/37.8
R509	7030007300	S.RES ERJ2GEJ 332 X (3.3K)	B	155.4/44.6
R510	7030005530	S.RES ERJ2GEJ 100 X (10)	B	106.8/30.6
R511	7030005160	S.RES ERJ2GEJ 105 X (1M)	B	105.9/30.6
R512	7510001730	S.THE ERTJOEP 473J	B	103.1/48.9
R513	7030005120	S.RES ERJ2GEJ 102 X (1K)	B	102.2/49.9
R514	7030008010	S.RES ERJ2GEJ 123 X (12K)	B	113.1/32.3
R515	7030008010	S.RES ERJ2GEJ 123 X (12K)	B	112.3/36.0
R516	7030005050	S.RES ERJ2GEJ 103 X (10K)	B	103.2/26.4
R517	7030008010	S.RES ERJ2GEJ 123 X (12K)	B	110.3/33.1
R518	7410001140	S.ARR EXB28V104JX	B	107.0/47.1
R519	7030005090	S.RES ERJ2GEJ 104 X (100K)	B	105.4/48.5
R520	7030005090	S.RES ERJ2GEJ 104 X (100K)	B	96.1/30.8
R523	7030005710	S.RES ERJ2GEJ 121 X (120)	B	114.1/37.6
R524	7030005090	S.RES ERJ2GEJ 104 X (100K)	B	104.5/48.5
R525	7030005710	S.RES ERJ2GEJ 121 X (120)	B	113.2/37.6
R526	7030005710	S.RES ERJ2GEJ 121 X (120)	B	112.3/37.6
R532	7030005120	S.RES ERJ2GEJ 102 X (1K)	B	33.2/45.5
R533	7030009140	S.RES ERJ2GEJ 272 X (2.7K)	B	31.2/47.7
R534	7030008290	S.RES ERJ2GEJ 183 X (18K)	B	32.3/45.8
R536	7030005090	S.RES ERJ2GEJ 104 X (100K)	B	158.7/30.8
R538	7030005090	S.RES ERJ2GEJ 104 X (100K)	B	155.7/29.3
R539	7030005040	S.RES ERJ2GEJ 472 X (4.7K)	B	27.7/51.1
R540	7030005040	S.RES ERJ2GEJ 472 X (4.7K)	B	26.6/49.9
R541	7030005050	S.RES ERJ2GEJ 103 X (10K)	B	139.2/32.0
R542	7030005080	S.RES ERJ2GEJ 823 X (82K)	B	26.2/51.1
R543	7030005050	S.RES ERJ2GEJ 103 X (10K)	B	137.4/31.5
R544	7030005240	S.RES ERJ2GEJ 473 X (47K)	B	164.9/29.4
R545	7030004980	S.RES ERJ2GEJ 101 X (100)	B	140.4/19.9
R546	7030005120	S.RES ERJ2GEJ 102 X (1K)	B	164.9/27.8
R547	7030005120	S.RES ERJ2GEJ 102 X (1K)	B	155.7/27.7
R548	7030005120	S.RES ERJ2GEJ 102 X (1K)	B	159.8/28.0
R549	7030005040	S.RES ERJ2GEJ 472 X (4.7K)	B	32.0/51.3
R551	7210003050	VAR EVU-F2KFK3 B14 (10KB)		
R552	7030005050	S.RES ERJ2GEJ 103 X (10K)	B	142.3/20.4
R553	7030005050	S.RES ERJ2GEJ 103 X (10K)	B	144.7/20.2
R554	7030005120	S.RES ERJ2GEJ 102 X (1K)	B	32.6/53.4
R556	7030005240	S.RES ERJ2GEJ 473 X (47K)	B	161.1/19.0
R557	7030005040	S.RES ERJ2GEJ 472 X (4.7K)	B	29.3/51.3
R558	7030008370	S.RES ERJ2GEJ 561 X (560)	B	169.2/51.1
R559	7030008370	S.RES ERJ2GEJ 561 X (560)	B	155.8/51.1
R560	7030010040	S.RES ERJ2GEJ-JPW	B	139.5/17.2
R562	7030003720	S.RES ERJ3GEYJ 224 V (220K)	B	86.2/43.7
R563	7030003720	S.RES ERJ3GEYJ 224 V (220K)	B	88.2/44.9
R564	7030009320	S.RES ERJ2GEJ 4R7 X (4.7)	B	153.1/19.8
R566	7030008370	S.RES ERJ2GEJ 561 X (560)	B	162.0/49.2
R567	7030008370	S.RES ERJ2GEJ 561 X (560)	B	148.3/49.9
R568	7030005050	S.RES ERJ2GEJ 103 X (10K)	B	87.5/17.0
R570	7030005220	S.RES ERJ2GEJ 223 X (22K)	B	103.1/24.8
R571	7030005070	S.RES ERJ2GEJ 683 X (68K)	B	45.8/51.6
R572	7030005090	S.RES ERJ2GEJ 104 X (100K)	B	46.3/50.3
R573	7030005090	S.RES ERJ2GEJ 104 X (100K)	B	108.4/33.0

M.=Mounted side (T: Mounted on the Top side, B: Mounted on the Bottom side)
S.=Surface mount

[FRONT UNIT]

REF NO.	PARTS NO.	DESCRIPTION	M.	H/V LOCATION
R574	7030005090	S.RES ERJ2GEJ 104 X (100K)	B	108.4/32.1
R575	7030005050	S.RES ERJ2GEJ 103 X (10K)	B	34.8/24.7
R576	7030005050	S.RES ERJ2GEJ 103 X (10K)	B	62.6/12.9
C500	4030016930	S.CER C1005 JB 1A 104K-T	B	79.4/47.9
C501	4030016930	S.CER C1005 JB 1A 104K-T	B	80.9/47.5
C502	4030016930	S.CER C1005 JB 1A 104K-T	B	80.9/46.6
C503	4030016930	S.CER C1005 JB 1A 104K-T	B	80.4/45.3
C504	4030016930	S.CER C1005 JB 1A 104K-T	B	81.0/41.0
C505	4030017490	S.CER C1608 JB 1A 105K-T	B	84.0/39.8
C506	4030017460	S.CER C1005 JB 1H 102K-T	B	80.9/39.5
C507	4030017490	S.CER C1608 JB 1A 105K-T	B	146.4/41.2
C508	4030017730	S.CER C1005 JB 1H 471K-T	B	159.8/34.4
C509	4030017730	S.CER C1005 JB 1H 471K-T	B	159.9/41.2
C510	4030017730	S.CER C1005 JB 1H 471K-T	B	146.4/34.4
C511	4030017730	S.CER C1005 JB 1H 471K-T	B	104.8/21.8
C512	4030017030	S.CER C1005 JB 1A 273K-T	B	106.4/29.4
C513	4030017630	S.CER C1005 CH 1H 120J-T	B	157.7/44.6
C514	4030017420	S.CER C1005 CH 1H 470J-T	B	103.6/50.3
C515	4030016790	S.CER C1005 JB 1E 103K-T	B	113.1/31.4
C516	4030017580	S.CER C1005 CH 1H 060C-T	B	102.2/50.8
C517	4030016930	S.CER C1005 JB 1A 104K-T	B	113.4/35.1
C518	4030016790	S.CER C1005 JB 1E 103K-T	B	111.3/31.8
C519	4030017640	S.CER C1005 CH 1H 150J-T	B	105.2/27.1
C520	4030016930	S.CER C1005 JB 1A 104K-T	B	105.0/30.1
C521	4030018900	S.CER C1005 JB 0J 474K-T	B	46.7/33.3
C522	4550006480	S.TAN TEESVA 1C 475M8R	B	45.0/31.1
C523	4030017330	S.CER C1005 JF 1C 104Z-T	B	49.9/29.5
C524	4030016790	S.CER C1005 JB 1E 103K-T	B	49.0/27.8
C525	4550006250	S.TAN TEESVA 1A 106M8R	B	48.9/26.2
C526	4030016930	S.CER C1005 JB 1A 104K-T	B	34.4/30.0
C527	4030016930	S.CER C1005 JB 1A 104K-T	B	34.6/55.4
C530	4030017460	S.CER C1005 JB 1H 102K-T	B	106.6/20.2
C531	4550006250	S.TAN TEESVA 1A 106M8R	B	31.4/45.8
C532	4030017460	S.CER C1005 JB 1H 102K-T	B	45.4/27.1
C533	4030017460	S.CER C1005 JB 1H 102K-T	B	62.1/14.2
C534	4030016930	S.CER C1005 JB 1A 104K-T	B	30.8/49.1
C535	4030016930	S.CER C1005 JB 1A 104K-T	B	161.0/28.5
C536	4030017460	S.CER C1005 JB 1H 102K-T	B	33.6/53.4
C537	4030017460	S.CER C1005 JB 1H 102K-T	B	26.6/49.0
C538	4030018860	S.CER C1005 JB 0J 105K-T	B	154.8/27.7
C539	4030017420	S.CER C1005 CH 1H 470J-T	B	36.9/59.5
C540	4510008590	S.ELE EEE1AA101SP	B	150.2/20.0
C541	4030017330	S.CER C1005 JF 1C 104Z-T	B	139.4/19.9
C542	4030017460	S.CER C1005 JB 1H 102K-T	B	29.7/60.9
C544	4550006250	S.TAN TEESVA 1A 106M8R	B	168.1/28.2
C545	4030017420	S.CER C1005 CH 1H 470J-T	B	137.4/32.4
C546	4030017420	S.CER C1005 CH 1H 470J-T	B	134.3/32.5
C547	4030017420	S.CER C1005 CH 1H 470J-T	B	161.0/27.5
C548	4030017460	S.CER C1005 JB 1H 102K-T	B	44.2/47.5
C549	4030017460	S.CER C1005 JB 1H 102K-T	B	158.1/19.3
C551	4030017420	S.CER C1005 CH 1H 470J-T	B	140.7/17.6
C553	4030017420	S.CER C1005 CH 1H 470J-T	B	148.6/18.0
C555	4030018860	S.CER C1005 JB 0J 105K-T	B	143.2/23.6
C556	4030016790	S.CER C1005 JB 1E 103K-T	B	143.5/22.1
C558	4550006480	S.TAN TEESVA 1C 475M8R	B	166.3/51.1
C559	4030017730	S.CER C1005 JB 1H 471K-T	B	153.1/51.2
C560	4030017730	S.CER C1005 JB 1H 471K-T	B	162.0/47.0
C561	4030017730	S.CER C1005 JB 1H 471K-T	B	147.4/46.7
C562	4030017730	S.CER C1005 JB 1H 471K-T	B	105.2/28.1
C563	4030016930	S.CER C1005 JB 1A 104K-T	B	103.2/28.0
C564	4030016930	S.CER C1005 JB 1A 104K-T	B	44.0/29.9
C565	4030016930	S.CER C1005 JB 1A 104K-T	B	42.9/49.5
C566	4030017460	S.CER C1005 JB 1H 102K-T	B	42.9/50.4
C567	4030016930	S.CER C1005 JB 1A 104K-T	B	67.3/6.6
C568	4030017460	S.CER C1005 JB 1H 102K-T	B	89.7/40.7
C569	4550006250	S.TAN TEESVA 1A 106M8R	B	34.8/23.8
C573	4030016930	S.CER C1005 JB 1A 104K-T	B	62.6/12.0
C574	4030016930	S.CER C1005 JB 1A 104K-T	B	106.0/11.4
C575	4510009020	S.ELE EEE0JA331P	B	
J501	6510019121	S.CON S8B-PH-SM4-TB(LF)(SN)	B	26.9/27.6
J502	6510019121	S.CON S8B-PH-SM4-TB(LF)(SN)	B	52.9/15.2
J503	6450002210	CON 3017-8821 <KIN>		
J504	6510014961	S.CON B2B-ZR-SM4-TF(LF)(SN)	B	18.4/57.1
DS500	5030002811	LCD L4-0013TVY-2 <TES>		
DS501	5040002710	LED EMPG3338S		
DS502	5040002720	LED EMVR3338S		
DS503	5040002710	LED EMPG3338S		
DS504	5040002720	LED EMVR3338S		
DS505	5040002310	S.LED SML-311YTT86	T	111.3/43.2
DS506	5040002310	S.LED SML-311YTT86	T	101.3/43.2
DS507	5040002310	S.LED SML-311YTT86	T	91.3/43.2
DS508	5040002310	S.LED SML-311YTT86	T	81.3/43.2
DS509	5040002310	S.LED SML-311YTT86	T	71.3/43.2
DS510	5040002310	S.LED SML-311YTT86	T	61.3/43.2
DS511	5040002150	LED VRPG3349S-734		
DS512	5040002150	LED VRPG3349S-734		
S506	2250000511	ENC RH70N1037E20-13F-2781		
SP501	2510001221	SPE C052SB500-14 <OSC>		
W501	8900011800	CAB OPC-1199		
W502	8900017540	CAB OPC-1785		
EP501	8930065150	LCD SRCN-2781-SP-N-W (SHJ)		
EP503	6910019600	SPA LM-5		
EP504	6910019610	SPA LM-7 (SPACER)		

[CONNECT UNIT]

REF NO.	PARTS NO.	DESCRIPTION	M.	H/V LOCATION
C601	4030017420	S.CER C1005 CH 1H 470J-T	T	97.6/111.3
C602	4030017400	S.CER C1005 CH 1H 220J-T	T	12.2/12.4
C603	4030017420	S.CER C1005 CH 1H 470J-T	T	16.6/12.4
C604	4030017400	S.CER C1005 CH 1H 220J-T	T	15.0/14.2
C605	4030017420	S.CER C1005 CH 1H 470J-T	T	17.8/13.9
C606	4030017420	S.CER C1005 CH 1H 470J-T	T	19.4/12.4
C607	4030017420	S.CER C1005 CH 1H 470J-T	T	20.6/13.9
C608	4030017420	S.CER C1005 CH 1H 470J-T	T	22.7/12.4
C609	4030017420	S.CER C1005 CH 1H 470J-T	T	25.5/12.4
C610	4030017420	S.CER C1005 CH 1H 470J-T	T	63.3/69.6
C611	4030017420	S.CER C1005 CH 1H 470J-T	T	31.0/14.1
C612	4030017420	S.CER C1005 CH 1H 470J-T	B	55.7/29.9
C613	4030017420	S.CER C1005 CH 1H 470J-T	T	33.6/14.1
C614	4030017420	S.CER C1005 CH 1H 470J-T	B	29.0/13.2
C615	4030017420	S.CER C1005 CH 1H 470J-T	T	35.8/12.8
C616	4030017420	S.CER C1005 CH 1H 470J-T	T	95.3/62.2
C617	4030017420	S.CER C1005 CH 1H 470J-T	T	59.8/65.0
C618	4030017420	S.CER C1005 CH 1H 470J-T	T	64.2/53.8
C619	4030017420	S.CER C1005 CH 1H 470J-T	T	76.8/109.5
C620	4030017420	S.CER C1005 CH 1H 470J-T	T	73.8/97.8
C621	4030017420	S.CER C1005 CH 1H 470J-T	T	31.5/2.8
J601	6510027920	S.CON IMSA-9631S-28Y934	B	22.8/16.2
J602	6510023210	CON CD6125SA1J0 <CVI>		
S1	2260003070	S.SWI MINISMDC150F/24-2	B	38.9/18.0
W601	8900017500	CAB OPC-1852 (P0.5N28L90) <TJM>		

M.=Mounted side (T: Mounted on the Top side, B: Mounted on the Bottom side)
S.=Surface mount

BOARD LAYOUTS

• MAIN UNIT (TOP VIEW)

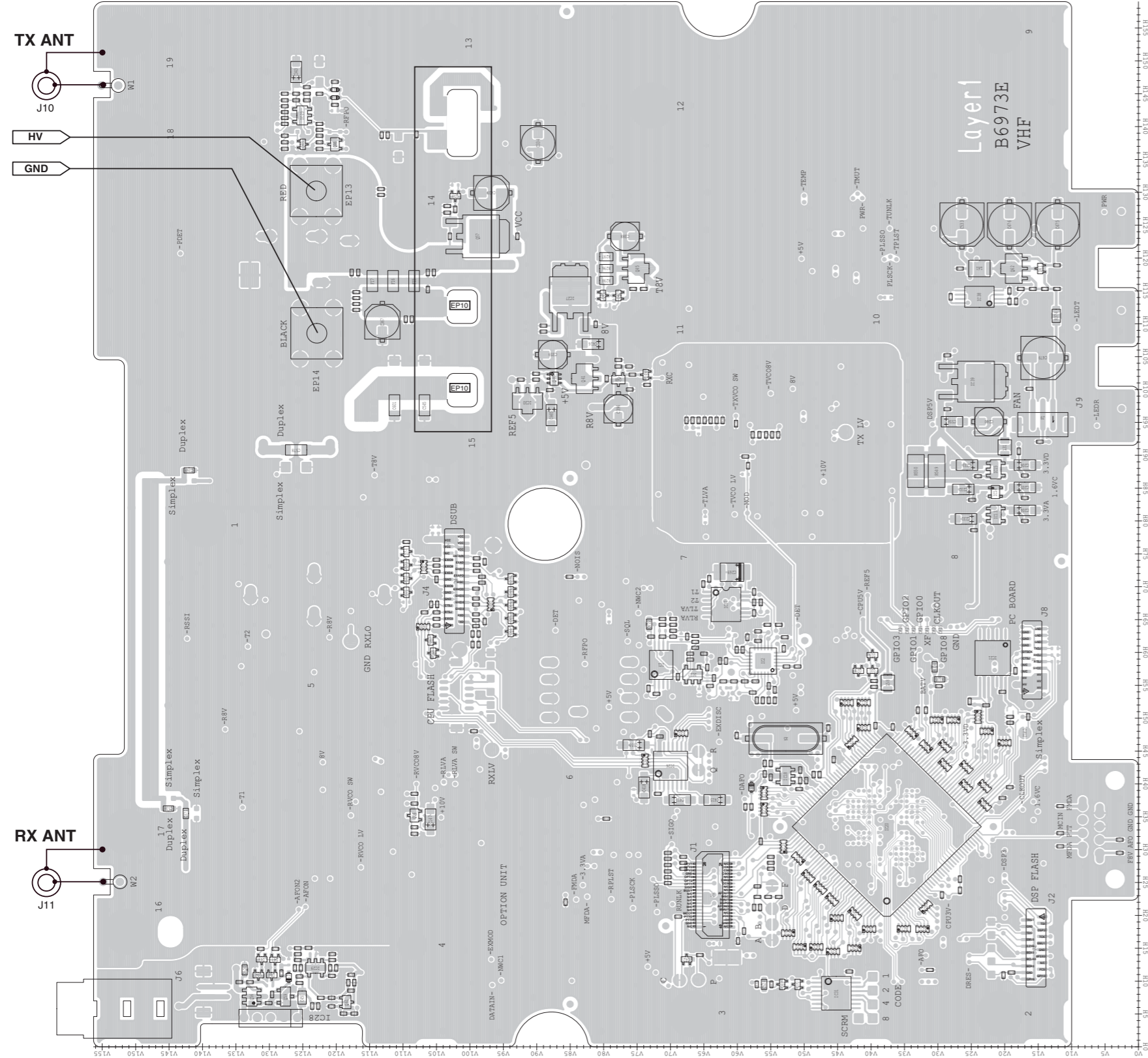

• FRONT UNIT (TOP VIEW)

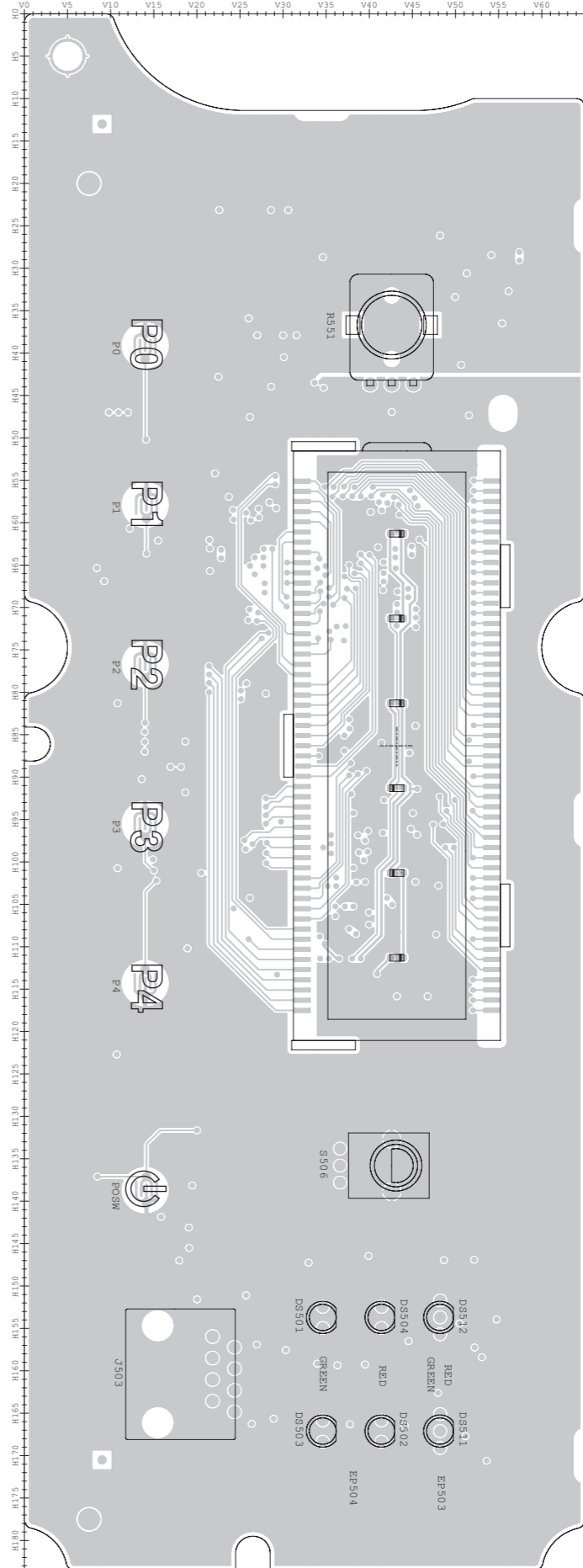

• CONNECT UNIT (TOP VIEW)

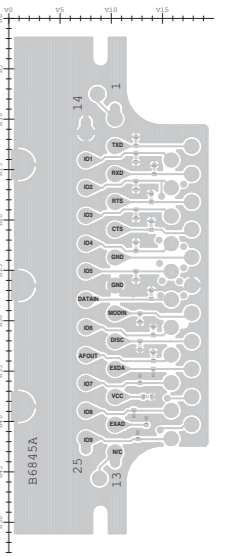

• CONNECT UNIT
(BOTTOM VIEW)

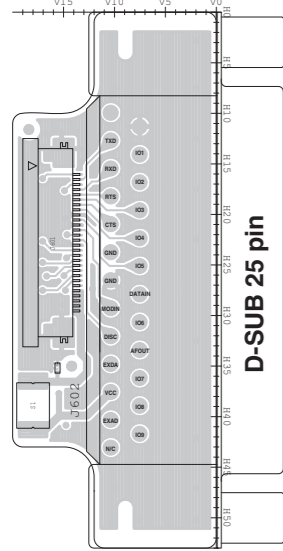

D-SUB 25 pin

• FRONT UNIT
(BOTTOM VIEW)

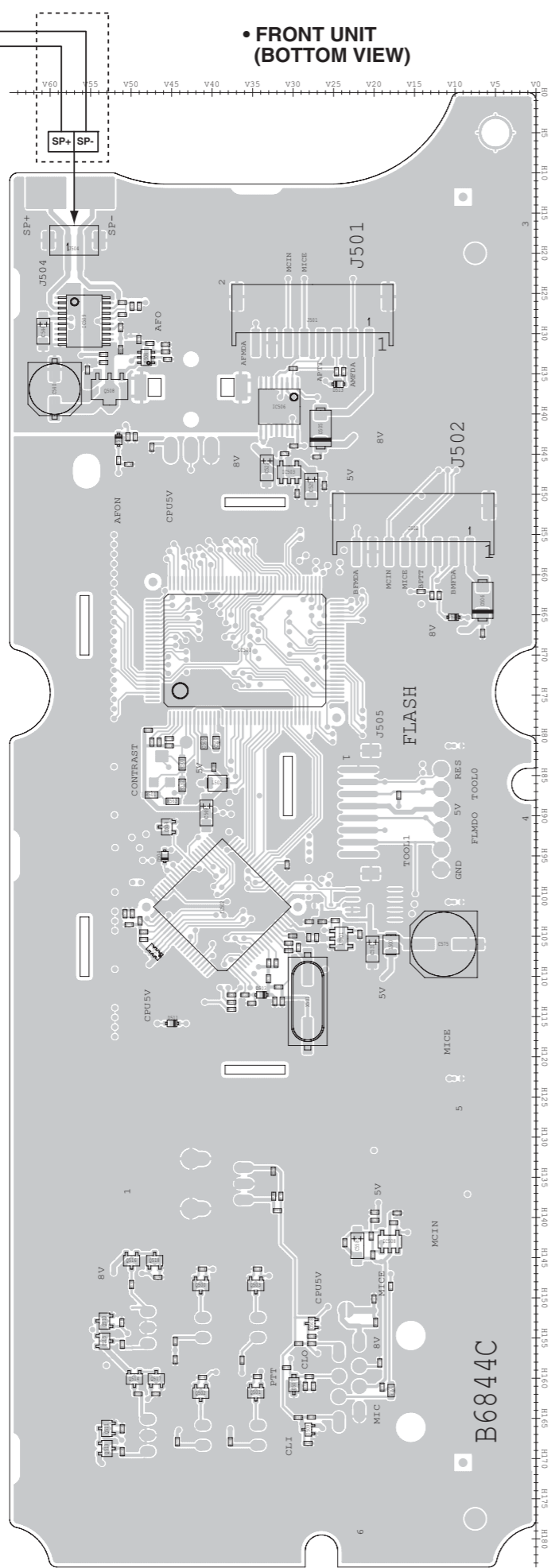

B6844C

• MAIN UNIT
(BOTTOM VIEW)

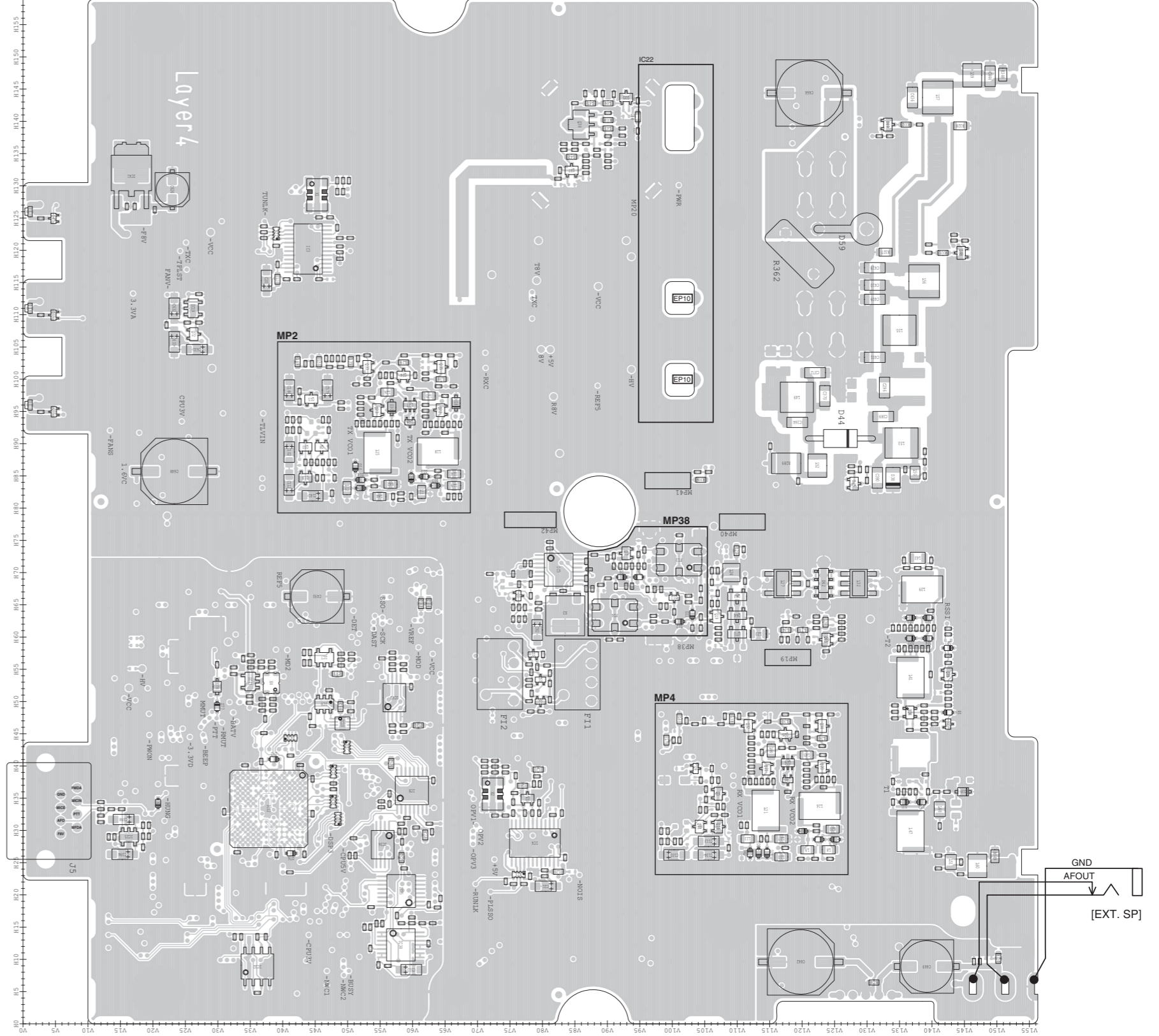

The combination of this side and the bottom side shows the board layout in the same configuration as the actual P.C.Board.

VOLTAGE DIAGRAM

FRONT UNIT

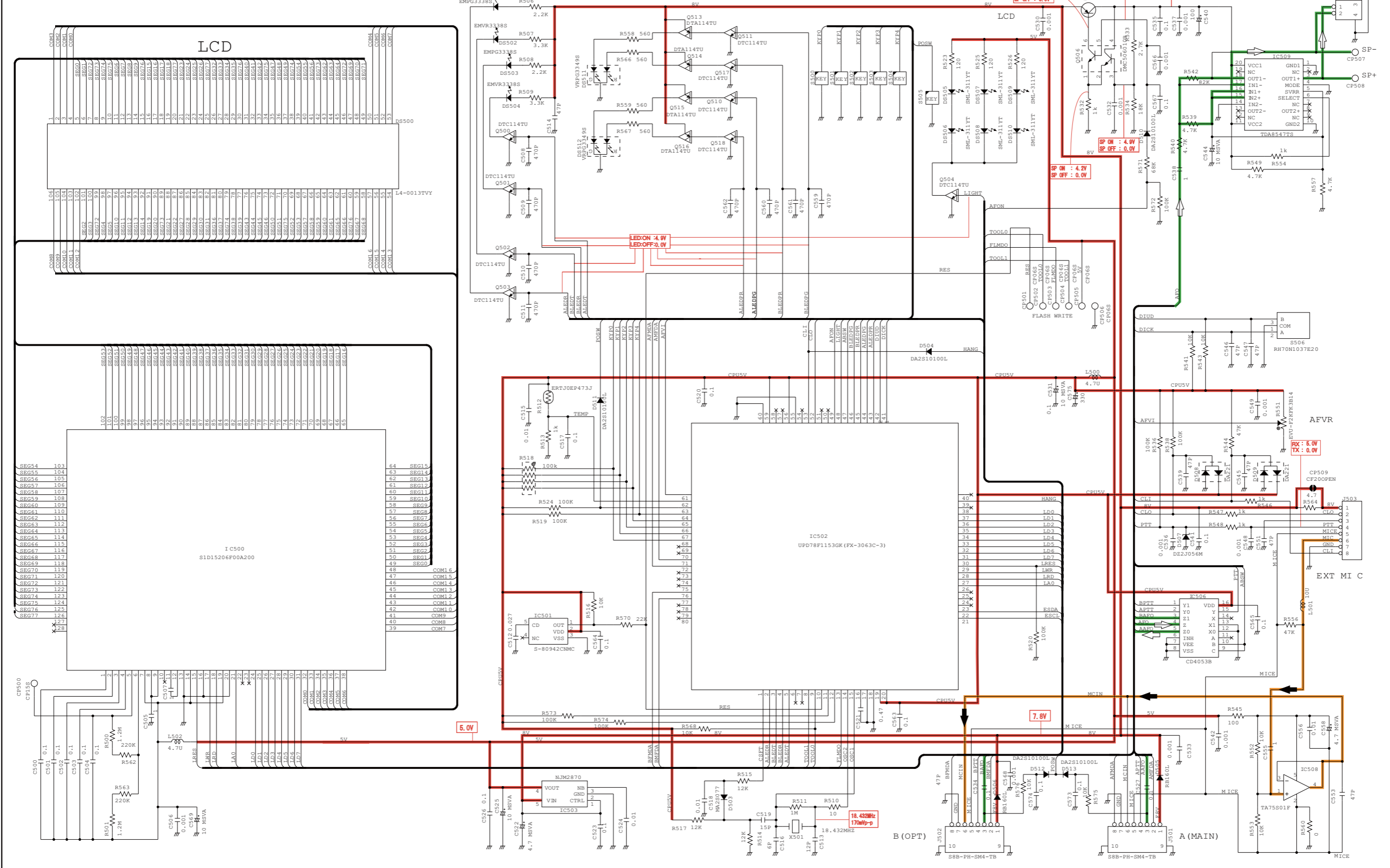

*; Refer to "PARTS LIST."

MAIN UNIT (2/3)

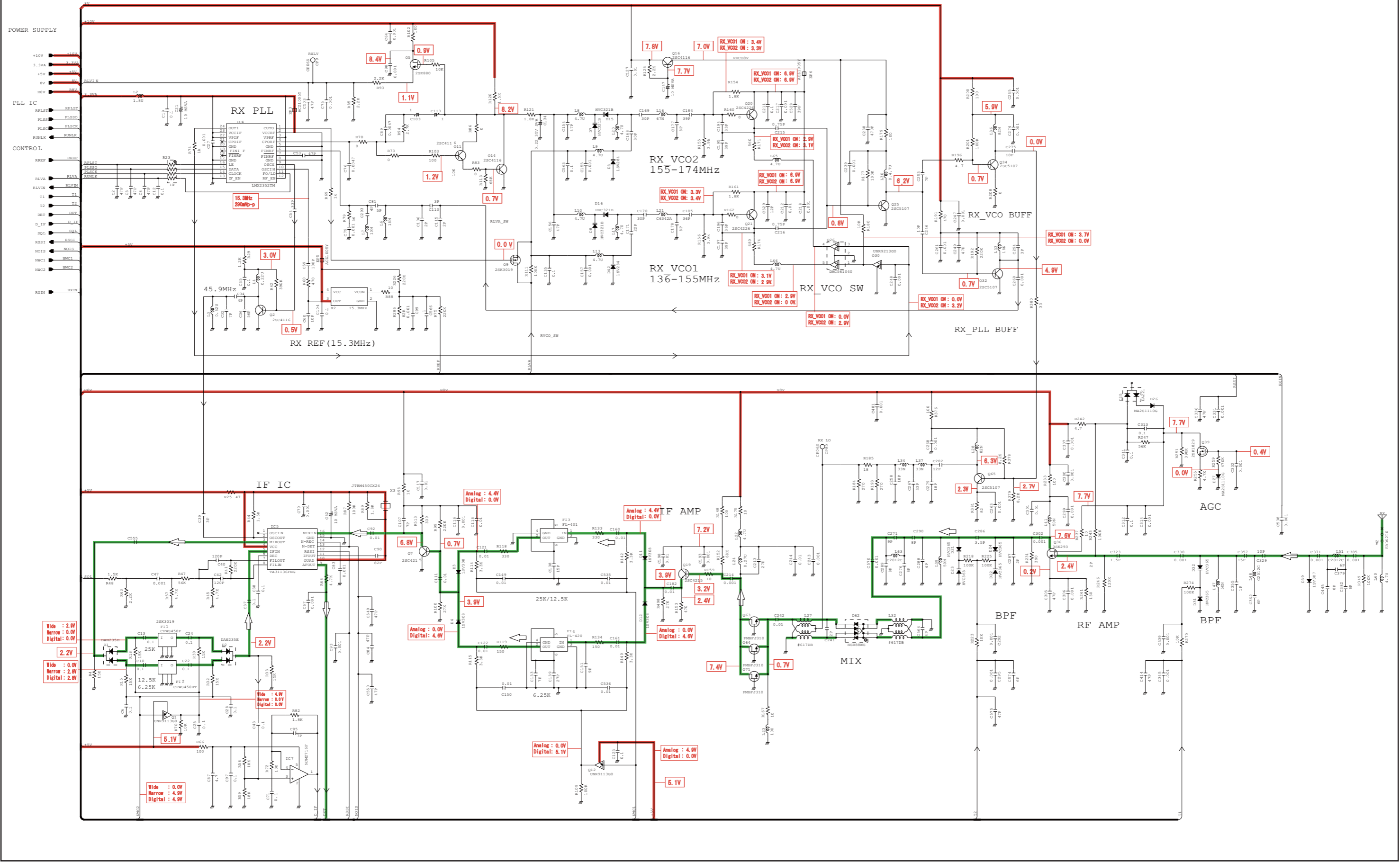

*; Refer to "PARTS LIST."

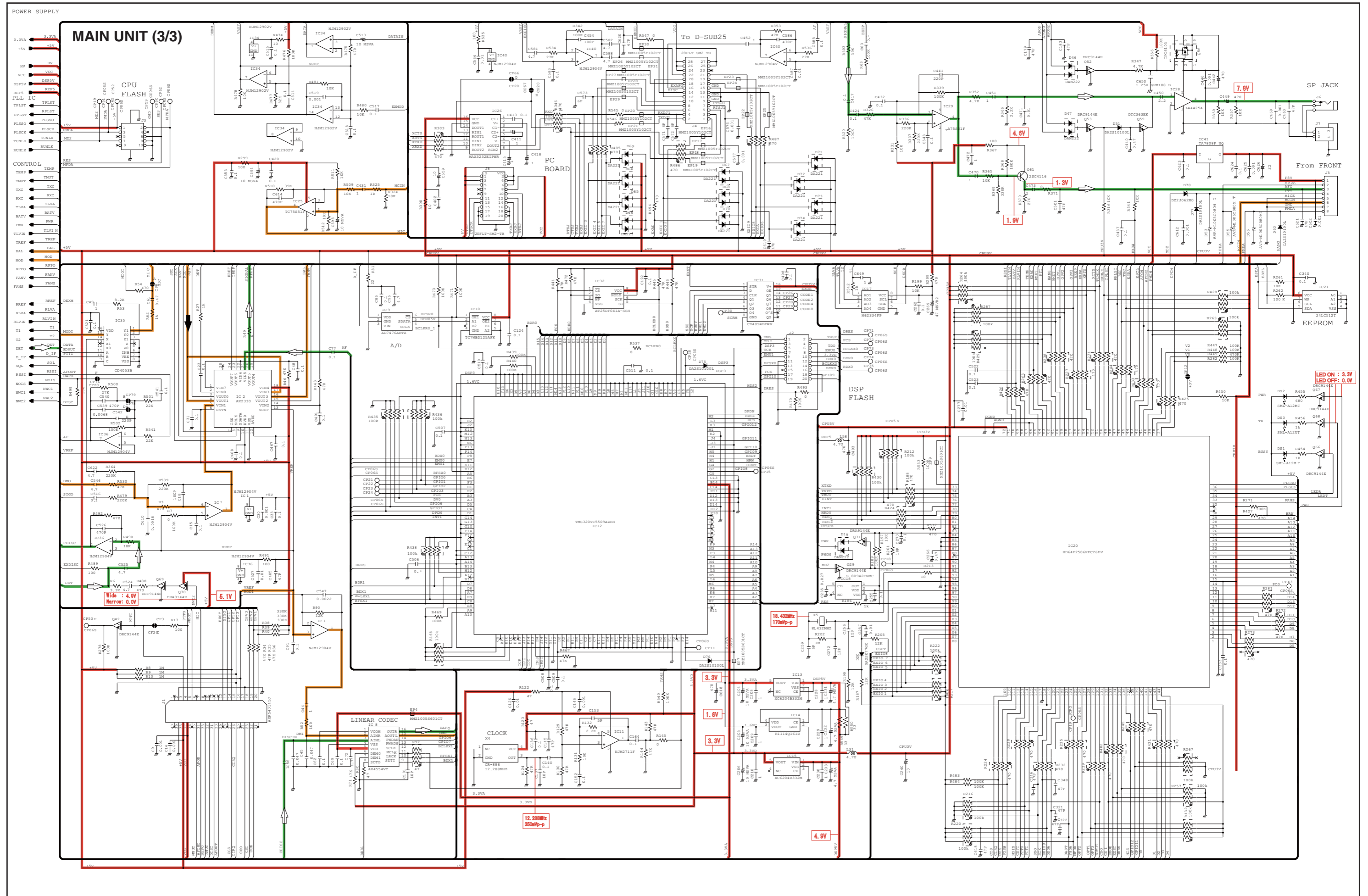

*; Refer to "PARTS LIST."

IC-FR5000 IC-FR5100

CONTENTS

REPLACEMENT PAGE	6-1
PARTS LIST	1
VOLTAGE DIAGRAM	9

[VERSION LIST]

Model	Version	Frequency range (MHz)	Channel spacing (kHz)	TX Power (W)
IC-FR5000	USA-01	136-174	7.5/15/30	50
	EXP-01		12.5/25.0	
	CHN-01		7.5/15/30	
IC-FR5100	EUR-01		12.5/20.0/25.0	25
	DPM-01		6.25/12.5/20.0/25.0	

SECTION 6 ADJUSTMENT PROCEDURE

6-1 PREPARATION

■ REQUIRED EQUIPMENTS

EQUIPMENT	SPECIFICATION	EQUIPMENT	SPECIFICATION
Adjustment Software	"CS-FR5000" (All models except [DPM-01]) "CS-FR5000(dPMR)" [DPM-01]	JIG cable	Modified OPC-1122U (USB type) (see the illust below)
Power Supply	Output voltage : 13.6 V DC [FR5000] : 13.2 V DC [FR5100] Current capacity : More than 20 A [FR5000] : More than 10 A [FR5100]	Attenuator	Power attenuation : 40 dB Capacity : More than 60 W [FR5000] : More than 30 W [FR5100]
RF Power Meter (terminated type)	Measuring range : 1–60 W [FR5000] : 1–30 W [FR5100] Frequency range : 100–300 MHz Impedance : 50 Ω SWR : Less than 1.2 : 1	Standard Signal Generator (SSG)	Frequency range : 0.1–300 MHz Output level : 0.1 mV to 32 mV (-127 to -17 dBm)
		Audio Generator	Frequency range : 300–3000 Hz Output level : 1–500 mV
Frequency Counter	Frequency range : 0.1–300 MHz Frequency accuracy : ±1 ppm or better Input level : Less than 1 mW	AC Millivoltmeter	Measuring range : 10 mV to 10 V
		Oscilloscope	Frequency range : DC–20 MHz Measuring range : 0.01–20 V
Modulation Analyzer	Frequency range : 30–300 MHz Measuring range : 0 to ±10 kHz	External Speaker	Input impedance : 4 Ω Capacity : More than 5 W

■ JIG CABLE

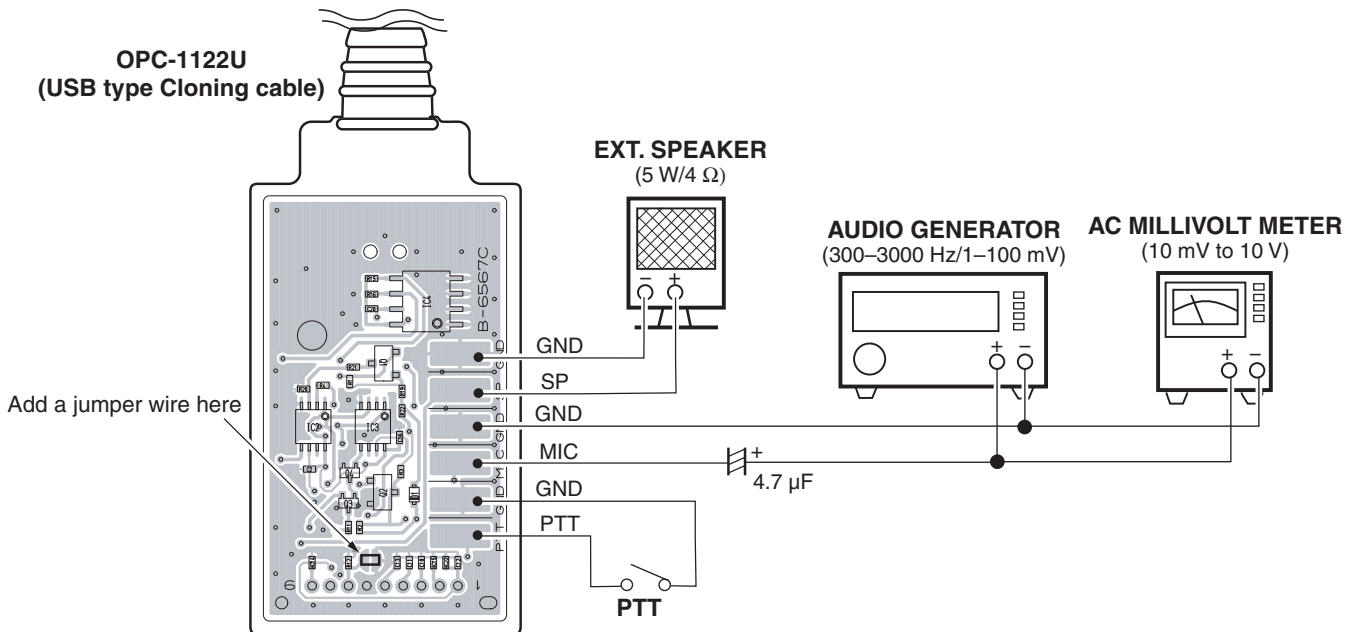

[MAIN UNIT]

Table with columns: REF NO., PARTS NO., DESCRIPTION, M., H/V LOCATION. Rows include parts like R468, R469, R470, etc., up to R550 and C1 through C42.

[MAIN UNIT]

Table with columns: REF NO., PARTS NO., DESCRIPTION, M., H/V LOCATION. Rows include parts like C43, C44, C45, etc., up to C163.

M.=Mounted side (T: Mounted on the Top side, B: Mounted on the Bottom side) S.=Surface mount

[MAIN UNIT]

REF NO.	PARTS NO.	DESCRIPTION	M.	H/V LOCATION
C619	4030017420	S.CER C1005 CH 1H 470J-T	T	76.8/109.5
C620	4030017420	S.CER C1005 CH 1H 470J-T	T	73.8/97.8
C621	4030017420	S.CER C1005 CH 1H 470J-T	T	31.5/2.8
C622	4030018910	S.CER C1608 JB 0J 475K-T	T	64.3/73.2
C623	4030017330	S.CER C1005 JF 1C 104Z-T	B	126.8/16
C624	4030017330	S.CER C1005 JF 1C 104Z-T	B	126.3/20.3
C625	4030017460	S.CER C1005 JB 1H 102K-T	B	126.8/17.2
C626	4510009810	S.ELE EEEFK1E220R	B	129.4/23
C629	4030016790	S.CER C1005 JB 1E 103K-T	B	113.2/27.1
C630	4030016930	S.CER C1005 JB 1A 104K-T	B	108.8/27.1
C631	4550007080	S.TAN TEESVA 1C 106M8R	B	104.6/26.8
C632	4550007080	S.TAN TEESVA 1C 106M8R	B	111/23.3
C633	4550007080	S.TAN TEESVA 1C 106M8R	B	105.8/23.3
C634	4030017460	S.CER C1005 JB 1H 102K-T	B	108.4/22.1
C648	4510009680	S.ELE EEEFK1E471P	B	85.7/23.3
C649	4030018860	S.CER C1005 JB 0J 105K-T	T	71.2/64.2
C650	4030019120	S.CER GRM188B31E105KA75D	T	11.7/133.7
J1	6510026770	S.CON AXK540147YG	T	23.1/63.7
J2	6510023092	S.CON 20FLT-SM2-TB(LF)(SN)(M)	T	14.8/15.6
J4	6510023512	S.CON 28FLT-SM2-TB(LF)(SN)(M)	T	70.8/102
J5	6510023110	CON 3008L-8P8C <KIN>		
J6	6450000140	CON HSJ0807-01-010		
J8	6510023092	S.CON 20FLT-SM2-TB(LF)(SN)(M)	T	59.1/15.6
J9	6510019371	S.CON B3B-ZR-SM4-TF(LF)(SN)	T	94.6/14.3
J10	6510004910	CON NR-DS-E 01 <NIP>		
J11	6510004910	CON NR-DS-E 01 <NIP>		
DS1	5040002961	S.LED SML-A12MT T86J	B	96/1.1
DS2	5040002961	S.LED SML-A12MT T86J	B	126/1.1
DS3	5040003001	S.LED SML-A12UT T86J	B	111/1.1
MF1	2710000870	FAN AFB0512HB-7X22 <USE>-HK		
EP1	6910015370	S.BEA ACZ1005Y-102-T	B	129.1/48.4
EP2	6910015370	S.BEA ACZ1005Y-102-T	B	115.5/45.6
EP3	6910015370	S.BEA ACZ1005Y-102-T	B	32.4/81.6
EP4	6910016330	S.BEA MMZ1005S 601CT-S	B	30.4/60.5
EP5	6910015370	S.BEA ACZ1005Y-102-T	B	39/74.3
EP6	6910015370	S.BEA ACZ1005Y-102-T	T	38.5/108.3
EP7	6910016330	S.BEA MMZ1005S 601CT-S	B	40.7/36.7
EP8	6910015370	S.BEA ACZ1005Y-102-T	B	95.4/49
EP9	6910016330	S.BEA MMZ1005S 601CT-S	T	48.8/39.3
EP10	6910011560	BEA HF70BB4.5X5X1.6		
EP13	6910011330	TER OT-009 M3		
EP14	6910011330	TER OT-009 M3		
EP16	6910018460	S.BEA MMZ1005Y102C-T	T	64.1/105
EP17	6910018460	S.BEA MMZ1005Y102C-T	T	65.1/105
EP18	6910018460	S.BEA MMZ1005Y102C-T	T	66.1/105
EP19	6910018460	S.BEA MMZ1005Y102C-T	T	66.1/106.8
EP20	6910018460	S.BEA MMZ1005Y102C-T	T	62.8/98.7
EP21	6910018460	S.BEA MMZ1005Y102C-T	T	62.8/99.6
EP22	6910018460	S.BEA MMZ1005Y102C-T	T	74.1/105
EP23	6910018460	S.BEA MMZ1005Y102C-T	T	73.2/105
EP24	6910018460	S.BEA MMZ1005Y102C-T	T	72.3/105
EP25	6910018460	S.BEA MMZ1005Y102C-T	T	71.1/105
EP26	6910018460	S.BEA MMZ1005Y102C-T	T	72.4/99
EP27	6910018460	S.BEA MMZ1005Y102C-T	T	68.2/99.1
EP28	6910018460	S.BEA MMZ1005Y102C-T	T	67.3/99.1
EP29	6910018460	S.BEA MMZ1005Y102C-T	T	65.8/99.1
EP30	6910018460	S.BEA MMZ1005Y102C-T	T	74.3/99
EP31	6910018460	S.BEA MMZ1005Y102C-T	T	70.6/98.2

[FRONT UNIT]

REF NO.	PARTS NO.	DESCRIPTION	M.	H/V LOCATION
IC500	1130009121	S.IC S1D15206F00A200	B	69.4/35.9
IC501	1110005771	S.IC S-80942CNMC-G9CT2G	B	105.3/24
IC502	1140014582	S.IC UPD78F1153GK(R)-GAK-AX (3063C-3)	B	101.3/38.7
IC503	1110005350	S.IC NJM2870F05-TE1-#FZZB	B	47.2/30.5
IC506	1140013200	S.IC CD4053BPWR	B	39.1/31.7
IC508	1110002751	S.IC TA75S01F(TE85R,F)	B	143/18
IC509	1110006770	S.IC TDA8547TS/N	B	28.4/55.8
Q500	1590001050	S.TRA DTC114TUA T106	B	148.4/41.4
Q501	1590001050	S.TRA DTC114TUA T106	B	161.8/34.6
Q502	1590001050	S.TRA DTC114TUA T106	B	161.8/41.4
Q503	1590001050	S.TRA DTC114TUA T106	B	148.4/34.6
Q504	1590001050	S.TRA DTC114TUA T106	B	91.4/45.6
Q506	1590001190	S.TRA XP6501-(TX).AB	B	32.9/48.1
Q508	1520000460	S.TRA 2SB1132 T100 R	B	36.9/52.6
Q510	1590001050	S.TRA DTC114TUA T106	B	152.8/53.2
Q511	1590001050	S.TRA DTC114TUA T106	B	166.2/53
Q513	1590001060	S.TRA DTA114TUA T106	B	168.7/53
Q514	1590001060	S.TRA DTA114TUA T106	B	160.1/49.6
Q515	1590001060	S.TRA DTA114TUA T106	B	155.3/53.2
Q516	1590001060	S.TRA DTA114TUA T106	B	145.3/49.9
Q517	1590001050	S.TRA DTC114TUA T106	B	160.1/46.9
Q518	1590001050	S.TRA DTC114TUA T106	B	145.3/47
D503	1790001261	S.DIO MA2S077G0L	B	112.3/33.9
D504	1790001251	S.DIO MA2S1110GL	B	95/45.8
D505	1790001450	S.DIO RB160L-40 TE-25	B	41.8/26.6
D506	1790001450	S.DIO RB160L-40 TE-25	B	63.2/6.6
D507	1790000951	S.ZEN MAZ8056GML	B	160.8/29.9
D508	1750000370	S.DIO DA221 TL	B	153.2/27.7
D509	1750000370	S.DIO DA221 TL	B	166.4/28.1
D510	1790001251	S.DIO MA2S1110GL	B	43.2/51.5
D511	1790001251	S.DIO MA2S1110GL	B	115.8/44.9
D512	1790001251	S.DIO MA2S1110GL	B	65.3/10.2
D513	1790001251	S.DIO MA2S1110GL	B	36.3/24.4
X501	6050012680	S.XTA CR-858(SMD-49/18.432 MHz) <JJE>	B	113.1/28.2
L500	6200002861	S.COI NLV25T-4R7J	B	106/17.9
L501	6200003640	S.COI MLF1608E 100K-T	B	161.5/17.9
L502	6200002861	S.COI NLV25T-4R7J	B	85.9/39.3
R500	7030003810	S.RES ERJ3GEYJ 125 V (1.2M)	B	83.5/43.7
R501	7030003810	S.RES ERJ3GEYJ 125 V (1.2M)	B	87.4/47.5
R506	7030007290	S.RES ERJ2GEJ 222 X (2.2K)	B	157.7/36.3
R507	7030007300	S.RES ERJ2GEJ 332 X (3.3K)	B	167.9/44.3
R508	7030007290	S.RES ERJ2GEJ 222 X (2.2K)	B	167.9/37.7
R509	7030007300	S.RES ERJ2GEJ 332 X (3.3K)	B	155.4/44.5
R510	7030005530	S.RES ERJ2GEJ 100 X (10)	B	106.8/30.5
R511	7030005160	S.RES ERJ2GEJ 105 X (1M)	B	105.8/30.5
R512	7510001730	S.THE ERTJOEP 473J	B	103.1/48.9
R513	7030005120	S.RES ERJ2GEJ 12 X (1K)	B	102.2/49.8
R514	7030008010	S.RES ERJ2GEJ 123 X (12K)	B	113.1/32.2
R515	7030008010	S.RES ERJ2GEJ 123 X (12K)	B	112.3/35.9
R516	7030005050	S.RES ERJ2GEJ 103 X (10K)	B	103.2/26.4
R517	7030008010	S.RES ERJ2GEJ 123 X (12K)	B	110.3/33
R518	7410001140	S.ARR EXB28V104JX	B	106.9/47.1
R519	7030005090	S.RES ERJ2GEJ 104 X (100K)	B	105.4/48.4
R520	7030005090	S.RES ERJ2GEJ 104 X (100K)	B	96.1/30.7
R523	7030005710	S.RES ERJ2GEJ 121 X (120)	B	114.1/37.6
R524	7030005090	S.RES ERJ2GEJ 104 X (100K)	B	104.4/48.4
R525	7030005710	S.RES ERJ2GEJ 121 X (120)	B	113.2/37.6
R526	7030005710	S.RES ERJ2GEJ 121 X (120)	B	112.3/37.6
R532	7030005120	S.RES ERJ2GEJ 102 X (1K)	B	33.2/45.5
R533	7030009140	S.RES ERJ2GEJ 272 X (2.7K)	B	31.2/47.7
R534	7030008290	S.RES ERJ2GEJ 183 X (18K)	B	32.2/45.7
R536	7030005090	S.RES ERJ2GEJ 104 X (100K)	B	158.7/30.8
R538	7030005090	S.RES ERJ2GEJ 104 X (100K)	B	155.7/29.3
R539	7030005040	S.RES ERJ2GEJ 472 X (4.7K)	B	27.6/51.1
R540	7030005040	S.RES ERJ2GEJ 472 X (4.7K)	B	26.6/49.9
R541	7030005050	S.RES ERJ2GEJ 103 X (10K)	B	139.1/31.9
R542	7030005080	S.RES ERJ2GEJ 823 X (82K)	B	26.1/51.1
R543	7030005050	S.RES ERJ2GEJ 103 X (10K)	B	137.3/31.5
R544	7030005240	S.RES ERJ2GEJ 473 X (47K)	B	164.9/29.3
R545	7030004980	S.RES ERJ2GEJ 101 X (100)	B	140.3/19.9
R546	7030005120	S.RES ERJ2GEJ 102 X (1K)	B	164.8/27.7
R547	7030005120	S.RES ERJ2GEJ 102 X (1K)	B	155.7/27.7
R548	7030005120	S.RES ERJ2GEJ 102 X (1K)	B	159.8/28
R549	7030005040	S.RES ERJ2GEJ 472 X (4.7K)	B	32/51.3
R551	7210003050	VAR EVU-F2KFK3 B14 (10KB)		
R552	7030005050	S.RES ERJ2GEJ 103 X (10K)	B	142.3/20.3
R553	7030005050	S.RES ERJ2GEJ 103 X (10K)	B	144.6/20.1
R554	7030005120	S.RES ERJ2GEJ 102 X (1K)	B	32.6/53.4
R556	7030005240	S.RES ERJ2GEJ 473 X (47K)	B	161.1/19
R557	7030005040	S.RES ERJ2GEJ 472 X (4.7K)	B	29.2/51.3
R558	7030008370	S.RES ERJ2GEJ 561 X (560)	B	169.1/51.1
R559	7030008370	S.RES ERJ2GEJ 561 X (560)	B	155.7/51
R560	7030010040	S.RES ERJ2GEJ-JPW	B	139.4/17.1
R562	7030003720	S.RES ERJ3GEYJ 224 V (220K)	B	86.2/43.7
R563	7030003720	S.RES ERJ3GEYJ 224 V (220K)	B	88.2/44.9
R564	7030009320	S.RES ERJ2GEJ 4R7 X (4.7)	B	153/19.8
R566	7030008370	S.RES ERJ2GEJ 561 X (560)	B	161.9/49.1
R567	7030008370	S.RES ERJ2GEJ 561 X (560)	B	148.3/49.9
R568	7030005050	S.RES ERJ2GEJ 103 X (10K)	B	87.4/16.9
R570	7030005220	S.RES ERJ2GEJ 223 X (22K)	B	103/24.8
R571	7030005070	S.RES ERJ2GEJ 683 X (68K)	B	45.8/51.5
R572	7030005090	S.RES ERJ2GEJ 104 X (100K)	B	46.2/50.3
R573	7030005090	S.RES ERJ2GEJ 104 X (100K)	B	108.3/33

M.=Mounted side (T: Mounted on the Top side, B: Mounted on the Bottom side)
S.=Surface mount

[FRONT UNIT]

REF NO.	PARTS NO.	DESCRIPTION	M.	H/V LOCATION
R574	7030005090	S.RES ERJ2GEJ 104 X (100K)	B	108.3/32.1
R575	7030005050	S.RES ERJ2GEJ 103 X (10K)	B	34.7/24.6
R576	7030005050	S.RES ERJ2GEJ 103 X (10K)	B	62.6/12.8
C500	4030016930	S.CER C1005 JB 1A 104K-T	B	79.3/47.9
C501	4030016930	S.CER C1005 JB 1A 104K-T	B	80.8/47.4
C502	4030016930	S.CER C1005 JB 1A 104K-T	B	80.8/46.5
C503	4030016930	S.CER C1005 JB 1A 104K-T	B	80.4/45.3
C504	4030016930	S.CER C1005 JB 1A 104K-T	B	81.3/45.3
C505	4030017490	S.CER C1608 JB 1A 105K-T	B	80.9/41
C506	4030017460	S.CER C1005 JB 1H 102K-T	B	83.9/39.8
C507	4030017490	S.CER C1608 JB 1A 105K-T	B	80.9/39.5
C508	4030017730	S.CER C1005 JB 1H 471K-T	B	146.4/41.2
C509	4030017730	S.CER C1005 JB 1H 471K-T	B	159.8/34.4
C510	4030017730	S.CER C1005 JB 1H 471K-T	B	159.9/41.2
C511	4030017730	S.CER C1005 JB 1H 471K-T	B	146.4/34.4
C512	4030017030	S.CER C1005 JB 1A 273K-T	B	104.7/21.7
C513	4030017630	S.CER C1005 CH 1H 120J-T	B	106.4/29.3
C514	4030017420	S.CER C1005 CH 1H 470J-T	B	157.7/44.5
C515	4030016790	S.CER C1005 JB 1E 103K-T	B	103.5/50.2
C516	4030017580	S.CER C1005 CH 1H 060C-T	B	113.1/31.3
C517	4030016930	S.CER C1005 JB 1A 104K-T	B	102.2/50.7
C518	4030016790	S.CER C1005 JB 1E 103K-T	B	113.3/35.1
C519	4030017640	S.CER C1005 CH 1H 150J-T	B	111.3/31.8
C520	4030016930	S.CER C1005 JB 1A 104K-T	B	105.1/27.1
C521	4030018900	S.CER C1005 JB 0J 474K-T	B	104.9/30
C522	4550006480	S.TAN TEESVA 1C 475M8R	B	46.7/33.2
C523	4030017330	S.CER C1005 JF 1C 104Z-T	B	44.9/31
C524	4030016790	S.CER C1005 JB 1E 103K-T	B	49.9/29.5
C525	4550006250	S.TAN TEESVA 1A 106M8R	B	49/27.7
C526	4030016930	S.CER C1005 JB 1A 104K-T	B	48.9/26.1
C527	4030016930	S.CER C1005 JB 1A 104K-T	B	34.3/30
C530	4030017460	S.CER C1005 JB 1H 102K-T	B	34.5/55.4
C531	4550006250	S.TAN TEESVA 1A 106M8R	B	106.6/20.2
C532	4030017460	S.CER C1005 JB 1H 102K-T	B	31.3/45.7
C533	4030017460	S.CER C1005 JB 1H 102K-T	B	45.3/27
C534	4030016930	S.CER C1005 JB 1A 104K-T	B	62.1/14.2
C535	4030016930	S.CER C1005 JB 1A 104K-T	B	30.7/49
C536	4030017460	S.CER C1005 JB 1H 102K-T	B	161/28.5
C537	4030017460	S.CER C1005 JB 1H 102K-T	B	33.6/53.4
C538	4030018860	S.CER C1005 JB 0J 105K-T	B	26.6/49
C539	4030017420	S.CER C1005 CH 1H 470J-T	B	154.8/27.7
C540	4510008590	S.ELE EEE1AA101SP	B	36.9/59.4
C541	4030017330	S.CER C1005 JF 1C 104Z-T	B	150.1/20
C542	4030017460	S.CER C1005 JB 1H 102K-T	B	139.3/19.9
C544	4550006250	S.TAN TEESVA 1A 106M8R	B	29.7/60.8
C545	4030017420	S.CER C1005 CH 1H 470J-T	B	168.1/28.1
C546	4030017420	S.CER C1005 CH 1H 470J-T	B	137.3/32.4
C547	4030017420	S.CER C1005 CH 1H 470J-T	B	134.2/32.4
C548	4030017460	S.CER C1005 JB 1H 102K-T	B	161/27.5
C549	4030017460	S.CER C1005 JB 1H 102K-T	B	44.1/47.4
C551	4030017420	S.CER C1005 CH 1H 470J-T	B	158.1/19.3
C553	4030017420	S.CER C1005 CH 1H 470J-T	B	140.6/17.6
C555	4030018860	S.CER C1005 JB 0J 105K-T	B	148.5/17.9
C556	4030016790	S.CER C1005 JB 1E 103K-T	B	143.1/23.6
C558	4550006480	S.TAN TEESVA 1C 475M8R	B	143.5/22
C559	4030017730	S.CER C1005 JB 1H 471K-T	B	166.3/51.1
C560	4030017730	S.CER C1005 JB 1H 471K-T	B	153.1/51.1
C561	4030017730	S.CER C1005 JB 1H 471K-T	B	161.9/46.9
C562	4030017730	S.CER C1005 JB 1H 471K-T	B	147.4/46.6
C563	4030016930	S.CER C1005 JB 1A 104K-T	B	105.1/28
C564	4030016930	S.CER C1005 JB 1A 104K-T	B	103.2/28
C565	4030016930	S.CER C1005 JB 1A 104K-T	B	44/29.9
C566	4030017460	S.CER C1005 JB 1H 102K-T	B	42.8/49.5
C567	4030016930	S.CER C1005 JB 1A 104K-T	B	42.8/50.4
C568	4030017460	S.CER C1005 JB 1H 102K-T	B	67.3/6.6
C569	4550006250	S.TAN TEESVA 1A 106M8R	B	89.6/40.7
C573	4030016930	S.CER C1005 JB 1A 104K-T	B	34.7/23.7
C574	4030016930	S.CER C1005 JB 1A 104K-T	B	62.6/11.9
C575	4510009020	S.ELE EEE0JA331P	B	106/11.4
J501	6510019121	S.CON S8B-PH-SM4-TB(LF)(SN)	B	26.9/27.5
J502	6510019121	S.CON S8B-PH-SM4-TB(LF)(SN)	B	52.9/15.1
J503	6450002210	CON 3017-8821 <KIN>		
J504	6510014961	S.CON B2B-ZR-SM4-TF(LF)(SN)	B	18.4/57
DS500	5030002811	LCD L4-0013TVY-2		
DS501	5040002710	LED EMPG3338S		
DS502	5040002720	LED EMVR3338S		
DS503	5040002710	LED EMPG3338S		
DS504	5040002720	LED EMVR3338S		
DS505	5040002310	S.LED SML-311YTT86	T	111.2/43.2
DS506	5040002310	S.LED SML-311YTT86	T	101.3/43.2
DS507	5040002310	S.LED SML-311YTT86	T	91.3/43.2
DS508	5040002310	S.LED SML-311YTT86	T	81.2/43.1
DS509	5040002310	S.LED SML-311YTT86	T	71.3/43.2
DS510	5040002310	S.LED SML-311YTT86	T	61.3/43.2
DS511	5040002150	LED VRPG3349S-734		
DS512	5040002150	LED VRPG3349S-734		
S506	2250000511	ENC RH70N1037E20-13F-2781		
SP501	2510001221	SPE C052SB500-14 <OSC>		
W501	8900011800	CAB OPC-1199		
W502	89000117540	CAB OPC-1785		
EP501	8930065150	LCD SRCN-2781-SP-N-W (SHJ)		

[CONNECT UNIT]

REF NO.	PARTS NO.	DESCRIPTION	M.	H/V LOCATION
C601	4030017420	S.CER C1005 CH 1H 470J-T	T	13.8/12.4
C602	4030017400	S.CER C1005 CH 1H 220J-T	T	12.2/12.4
C603	4030017420	S.CER C1005 CH 1H 470J-T	T	16.5/12.4
C604	4030017400	S.CER C1005 CH 1H 220J-T	T	15/14.2
C605	4030017420	S.CER C1005 CH 1H 470J-T	T	17.8/13.9
C606	4030017420	S.CER C1005 CH 1H 470J-T	T	19.4/12.4
C607	4030017400	S.CER C1005 CH 1H 470J-T	T	20.5/13.9
C608	4030017420	S.CER C1005 CH 1H 470J-T	T	22.6/12.4
C609	4030017420	S.CER C1005 CH 1H 470J-T	T	25.5/12.4
C610	4030017420	S.CER C1005 CH 1H 470J-T	T	29.7/12.8
C611	4030017420	S.CER C1005 CH 1H 470J-T	T	31/14.1
C612	4030017420	S.CER C1005 CH 1H 470J-T	T	32.4/12.8
C613	4030017420	S.CER C1005 CH 1H 470J-T	T	33.5/14.1
C614	4030017420	S.CER C1005 CH 1H 470J-T	T	35.2/14.1
C615	4030017420	S.CER C1005 CH 1H 470J-T	T	35.7/12.8
C616	4030017420	S.CER C1005 CH 1H 470J-T	B	35.2/15.6
C617	4030017420	S.CER C1005 CH 1H 470J-T	T	37.5/13.5
C618	4030017420	S.CER C1005 CH 1H 470J-T	T	39.3/12.2
C619	4030017420	S.CER C1005 CH 1H 470J-T	T	39.9/13.4
C620	4030017420	S.CER C1005 CH 1H 470J-T	T	41.3/12.6
C621	4030017420	S.CER C1005 CH 1H 470J-T	T	27.4/13.9
J601	6510026290	S.CON IMSA-9631S-28Y921	B	22.8/16.2
J602	6510023210	CON CD6125SA1J0 <CVI>		
S1	2260003070	S.SWI MINISMDC150F/24-2	B	38.9/18
W601	8900017500	CAB OPC-1852 (P0.5,N28,L90) <TJM>		

M.=Mounted side (T: Mounted on the Top side, B: Mounted on the Bottom side)
S.=Surface mount

VOLTAGE DIAGRAM

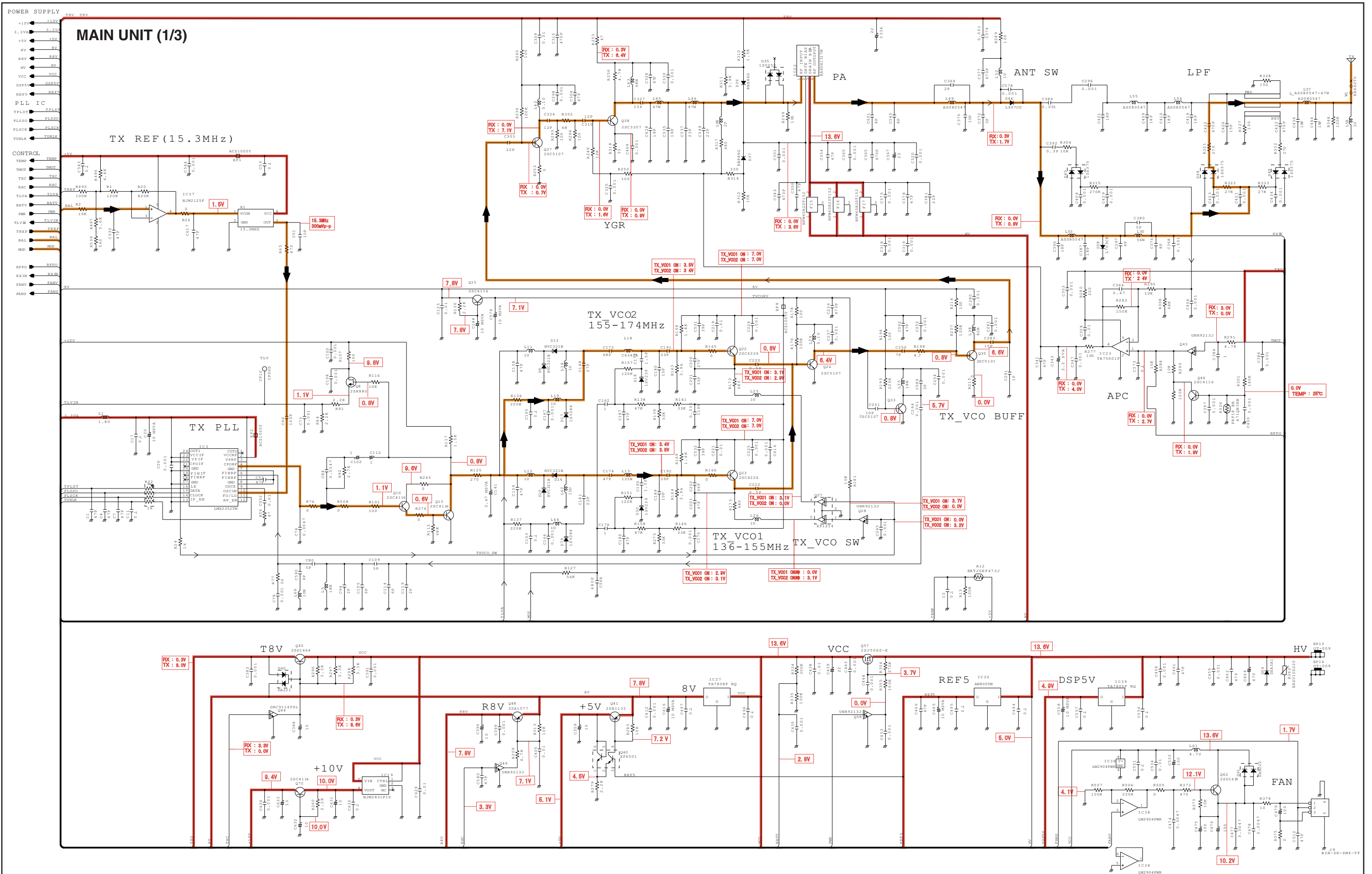

*; Refer to "PARTS LIST."

MAIN UNIT (2/3)

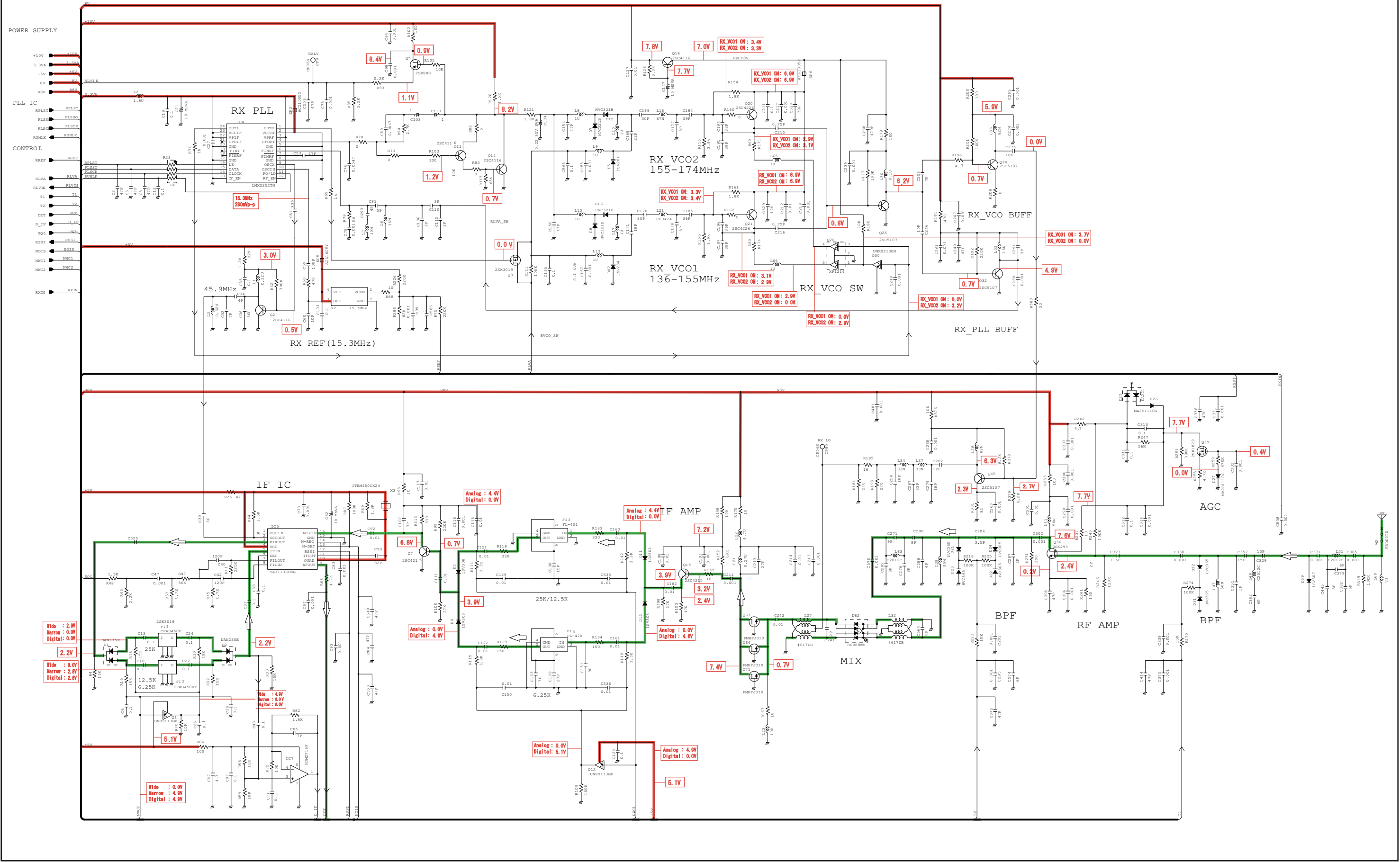

*; Refer to "PARTS LIST."

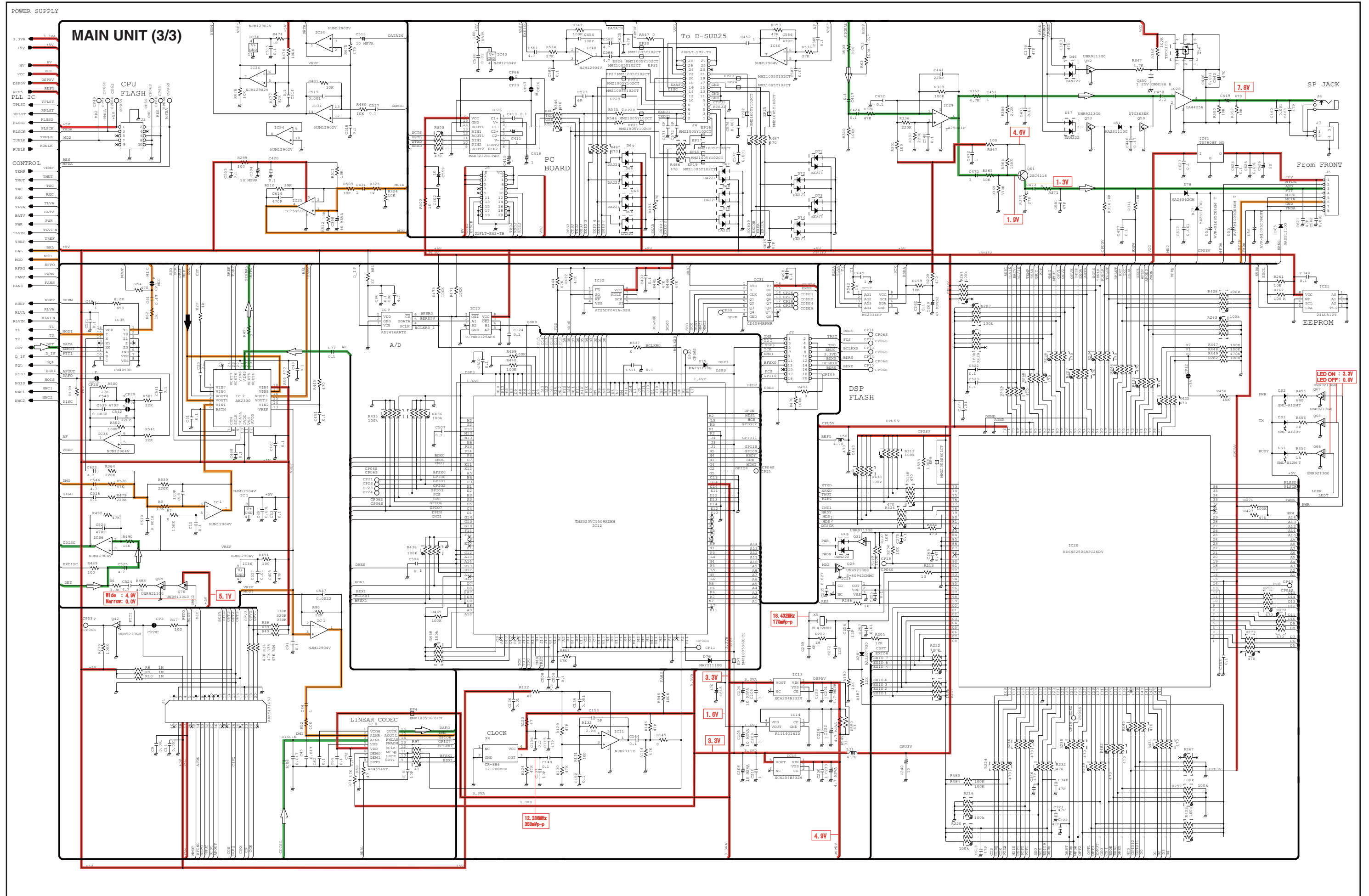

*; Refer to "PARTS LIST."

IC-FR5000 IC-FR5100

CONTENTS

PARTS LIST	1
BOARD LAYOUTS	10
VOLTAGE DIAGRAM	12

[VERSION LIST]

Model	Version	Frequency range (MHz)	Channel spacing (kHz)	TX Power (W)
IC-FR5000	USA-01	136-174	7.5/15/30	50
	EXP-01		12.5/25.0	
	CHN-01		7.5/15/30	
IC-FR5100	EUR-01		12.5/20/25	25

[FRONT UNIT]

REF NO.	PARTS NO.	DESCRIPTION	M.	H/V LOCATION
R574	7030005090	S.RES ERJ2GEJ 104 X (100K)	B	108.3/32.1
R575	7030005050	S.RES ERJ2GEJ 103 X (10K)	B	34.7/24.6
R576	7030005050	S.RES ERJ2GEJ 103 X (10K)	B	62.6/12.8
C500	4030016930	S.CER ECJ0EB1A104K	B	79.3/47.9
C501	4030016930	S.CER ECJ0EB1A104K	B	80.8/47.4
C502	4030016930	S.CER ECJ0EB1A104K	B	80.8/46.5
C503	4030016930	S.CER ECJ0EB1A104K	B	80.4/45.3
C504	4030016930	S.CER ECJ0EB1A104K	B	81.3/45.3
C505	4030017490	S.CER C1608 JB 1A 105K-T	B	80.9/41
C506	4030017460	S.CER ECJ0EB1E102K	B	83.9/39.8
C507	4030017490	S.CER C1608 JB 1A 105K-T	B	80.9/39.5
C508	4030017730	S.CER ECJ0EB1E471K	B	146.4/41.2
C509	4030017730	S.CER ECJ0EB1E471K	B	159.8/34.4
C510	4030017730	S.CER ECJ0EB1E471K	B	159.9/41.2
C511	4030017730	S.CER ECJ0EB1E471K	B	146.4/34.4
C512	4030017030	S.CER ECJ0EB1A273K	B	104.7/21.7
C513	4030017630	S.CER ECJ0EC1H120J	B	106.4/29.3
C514	4030017420	S.CER ECJ0EC1H470J	B	157.7/44.5
C515	4030016790	S.CER ECJ0EB1C103K	B	103.5/50.2
C516	4030017580	S.CER ECJ0EC1H060C	B	113.1/31.3
C517	4030016930	S.CER ECJ0EB1A104K	B	102.2/50.7
C518	4030016790	S.CER ECJ0EB1C103K	B	113.3/35.1
C519	4030017640	S.CER ECJ0EC1H150J	B	111.3/31.8
C520	4030016930	S.CER ECJ0EB1A104K	B	105.1/27.1
C521	4030018900	S.CER ECJ0EB0J474K	B	104.9/30
C522	4550006480	S.TAN TEESVA 1C 475M8R	B	46.7/33.2
C523	4030017330	S.CER ECJ0EF1C104Z	B	44.9/31
C524	4030016790	S.CER ECJ0EB1C103K	B	49.9/29.5
C525	4550006250	S.TAN TEESVA 1A 106M8R	B	49/27.7
C526	4030016930	S.CER ECJ0EB1A104K	B	48.9/26.1
C527	4030016930	S.CER ECJ0EB1A104K	B	34.3/30
C530	4030017460	S.CER ECJ0EB1E102K	B	34.5/55.4
C531	4550006250	S.TAN TEESVA 1A 106M8R	B	106.6/20.2
C532	4030017460	S.CER ECJ0EB1E102K	B	31.3/45.7
C533	4030017460	S.CER ECJ0EB1E102K	B	45.3/27
C534	4030016930	S.CER ECJ0EB1A104K	B	62.1/14.2
C535	4030016930	S.CER ECJ0EB1A104K	B	30.7/49
C536	4030017460	S.CER ECJ0EB1E102K	B	161/28.5
C537	4030017460	S.CER ECJ0EB1E102K	B	33.6/53.4
C538	4030018860	S.CER ECJ0EB0J105K	B	26.6/49
C539	4030017420	S.CER ECJ0EC1H470J	B	154.8/27.7
C540	4510008590	S.ELE EEE1AA101SP	B	36.9/59.4
C541	4030017330	S.CER ECJ0EF1C104Z	B	150.1/20
C542	4030017460	S.CER ECJ0EB1E102K	B	139.3/19.9
C544	4550006250	S.TAN TEESVA 1A 106M8R	B	29.7/60.8
C545	4030017420	S.CER ECJ0EC1H470J	B	168.1/28.1
C546	4030017420	S.CER ECJ0EC1H470J	B	137.3/32.4
C547	4030017420	S.CER ECJ0EC1H470J	B	134.2/32.4
C548	4030017460	S.CER ECJ0EB1E102K	B	161/27.5
C549	4030017460	S.CER ECJ0EB1E102K	B	44.1/47.4
C551	4030017420	S.CER ECJ0EC1H470J	B	158.1/19.3
C553	4030017420	S.CER ECJ0EC1H470J	B	140.6/17.6
C555	4030018860	S.CER ECJ0EB0J105K	B	148.5/17.9
C556	4030016790	S.CER ECJ0EB1C103K	B	143.1/23.6
C558	4550006480	S.TAN TEESVA 1C 475M8R	B	143.5/22
C559	4030017730	S.CER ECJ0EB1E471K	B	166.3/51.1
C560	4030017730	S.CER ECJ0EB1E471K	B	153.1/51.1
C561	4030017730	S.CER ECJ0EB1E471K	B	161.9/46.9
C562	4030017730	S.CER ECJ0EB1E471K	B	147.4/46.6
C563	4030016930	S.CER ECJ0EB1A104K	B	105.1/28
C564	4030016930	S.CER ECJ0EB1A104K	B	103.2/28
C565	4030016930	S.CER ECJ0EB1A104K	B	44/29.9
C566	4030017460	S.CER ECJ0EB1E102K	B	42.8/49.5
C567	4030016930	S.CER ECJ0EB1A104K	B	42.8/50.4
C568	4030017460	S.CER ECJ0EB1E102K	B	67.3/6.6
C569	4550006250	S.TAN TEESVA 1A 106M8R	B	89.6/40.7
C573	4030016930	S.CER ECJ0EB1A104K	B	34.7/23.7
C574	4030016930	S.CER ECJ0EB1A104K	B	62.6/11.9
C575	4510009020	S.ELE EEE0JA331P	B	106/11.4
J501	6510019121	S.CON S8B-PH-SM4-TB(LF)(SN)	B	26.9/27.5
J502	6510019121	S.CON S8B-PH-SM4-TB(LF)(SN)	B	52.9/15.1
J503	6450002210	CON 3017-8821 <KIN>		
J504	6510014961	S.CON B2B-ZR-SM4-TF(LF)(SN)	B	18.4/57
DS500	5030002811	LCD L4-0013TVVY-2		
DS501	5040002710	LED EMPG3338S		
DS502	5040002720	LED EMVR3338S		
DS503	5040002710	LED EMPG3338S		
DS504	5040002720	LED EMVR3338S		
DS505	5040002310	S.LED SML-311YTT86	T	111.2/43.2
DS506	5040002310	S.LED SML-311YTT86	T	101.3/43.2
DS507	5040002310	S.LED SML-311YTT86	T	91.3/43.2
DS508	5040002310	S.LED SML-311YTT86	T	81.2/43.1
DS509	5040002310	S.LED SML-311YTT86	T	71.3/43.2
DS510	5040002310	S.LED SML-311YTT86	T	61.3/43.2
DS511	5040002150	LED VRPG3349S-734		
DS512	5040002150	LED VRPG3349S-734		
S506	2250000511	ENC RH70N1037E20-13F-2781		
SP501	2510001221	SPE C052SB500-14 <OSC>		
W501	8900011800	CAB OPC-1199		
W502	89000117540	CAB OPC-1785		
EP501	8930065150	LCD SRCN-2781-SP-N-W (SHJ)		

[FRONT UNIT]

REF NO.	PARTS NO.	DESCRIPTION	M.	H/V LOCATION
EP503	6910019600	SPA LM-5		
EP504	6910019610	SPA LM-7 (SPACER)		

M.=Mounted side (T: Mounted on the Top side, B: Mounted on the Bottom side)
S.=Surface mount

[CONNECT UNIT]

REF NO.	PARTS NO.	DESCRIPTION	M.	H/V LOCATION
C601	4030017420	S.CER ECJ0EC1H470J	T	13.8/12.4
C602	4030017400	S.CER ECJ0EC1H220J	T	12.2/12.4
C603	4030017420	S.CER ECJ0EC1H470J	T	16.5/12.4
C604	4030017400	S.CER ECJ0EC1H220J	T	15/14.2
C605	4030017420	S.CER ECJ0EC1H470J	T	17.8/13.9
C606	4030017420	S.CER ECJ0EC1H470J	T	19.4/12.4
C607	4030017420	S.CER ECJ0EC1H470J	T	20.5/13.9
C608	4030017420	S.CER ECJ0EC1H470J	T	22.6/12.4
C609	4030017420	S.CER ECJ0EC1H470J	T	25.5/12.4
C610	4030017420	S.CER ECJ0EC1H470J	T	29.7/12.8
C611	4030017420	S.CER ECJ0EC1H470J	T	31/14.1
C612	4030017420	S.CER ECJ0EC1H470J	T	32.4/12.8
C613	4030017420	S.CER ECJ0EC1H470J	T	33.5/14.1
C614	4030017420	S.CER ECJ0EC1H470J	T	35.2/14.1
C615	4030017420	S.CER ECJ0EC1H470J	T	35.7/12.8
C616	4030017420	S.CER ECJ0EC1H470J	B	35.2/15.6
C617	4030017420	S.CER ECJ0EC1H470J	T	37.5/13.5
C618	4030017420	S.CER ECJ0EC1H470J	T	39.3/12.2
C619	4030017420	S.CER ECJ0EC1H470J	T	39.9/13.4
C620	4030017420	S.CER ECJ0EC1H470J	T	41.3/12.6
C621	4030017420	S.CER ECJ0EC1H470J	T	27.4/13.9
J601	6510026290	S.CON IMSA-9631S-28Y921	B	22.8/16.2
J602	6510023210	CON CD6125SA1J0 <CVI>		
S1	2260003070	S.SWI MINISMDC150F/24-2	B	38.9/18
W601	8900017500	CAB OPC-1852 (P0.5,N28,L90) <TJM>		

M.=Mounted side (T: Mounted on the Top side, B: Mounted on the Bottom side)
S.=Surface mount

BOARD LAYOUTS

• MAIN UNIT (TOP VIEW)

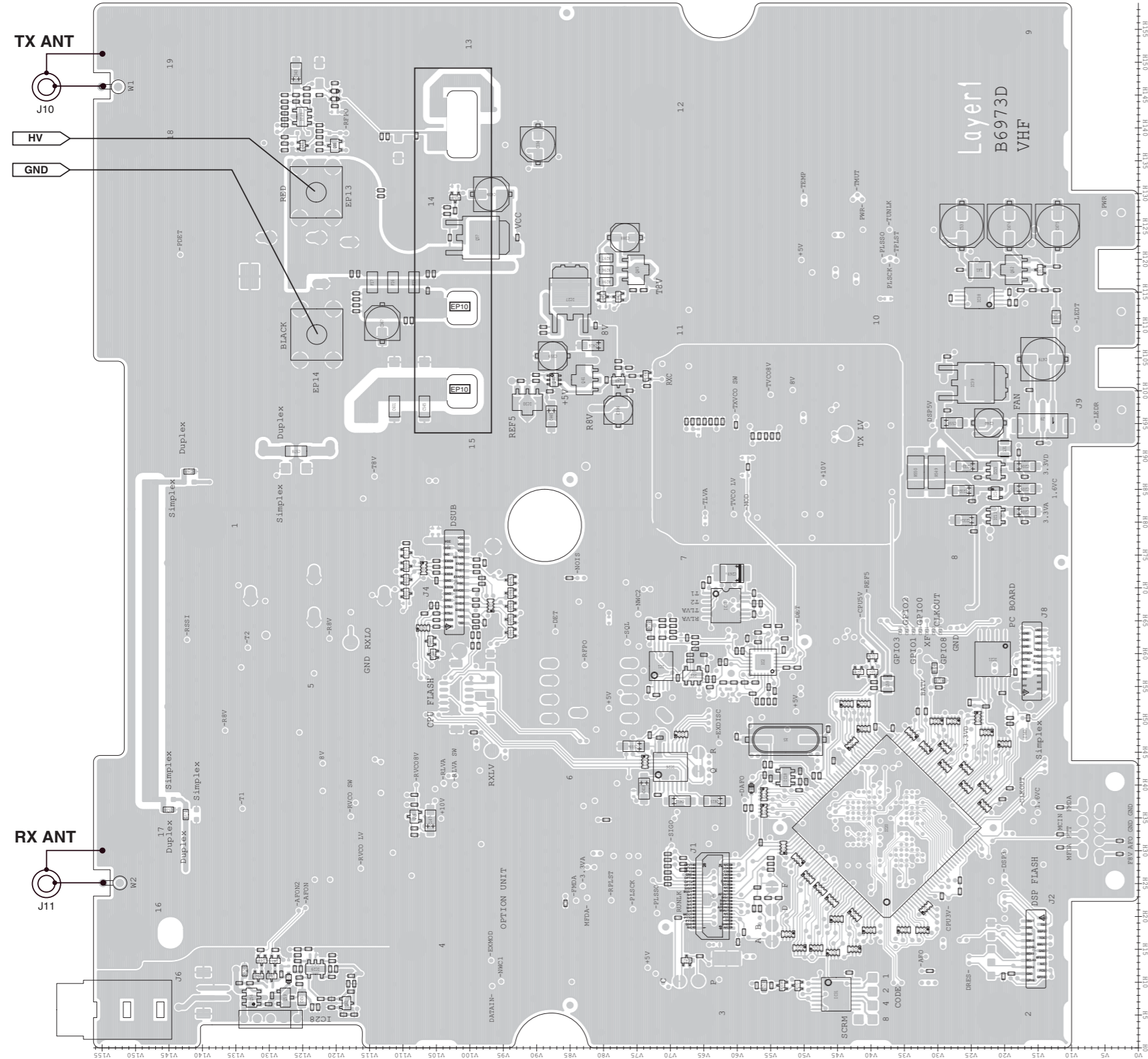

• FRONT UNIT (TOP VIEW)

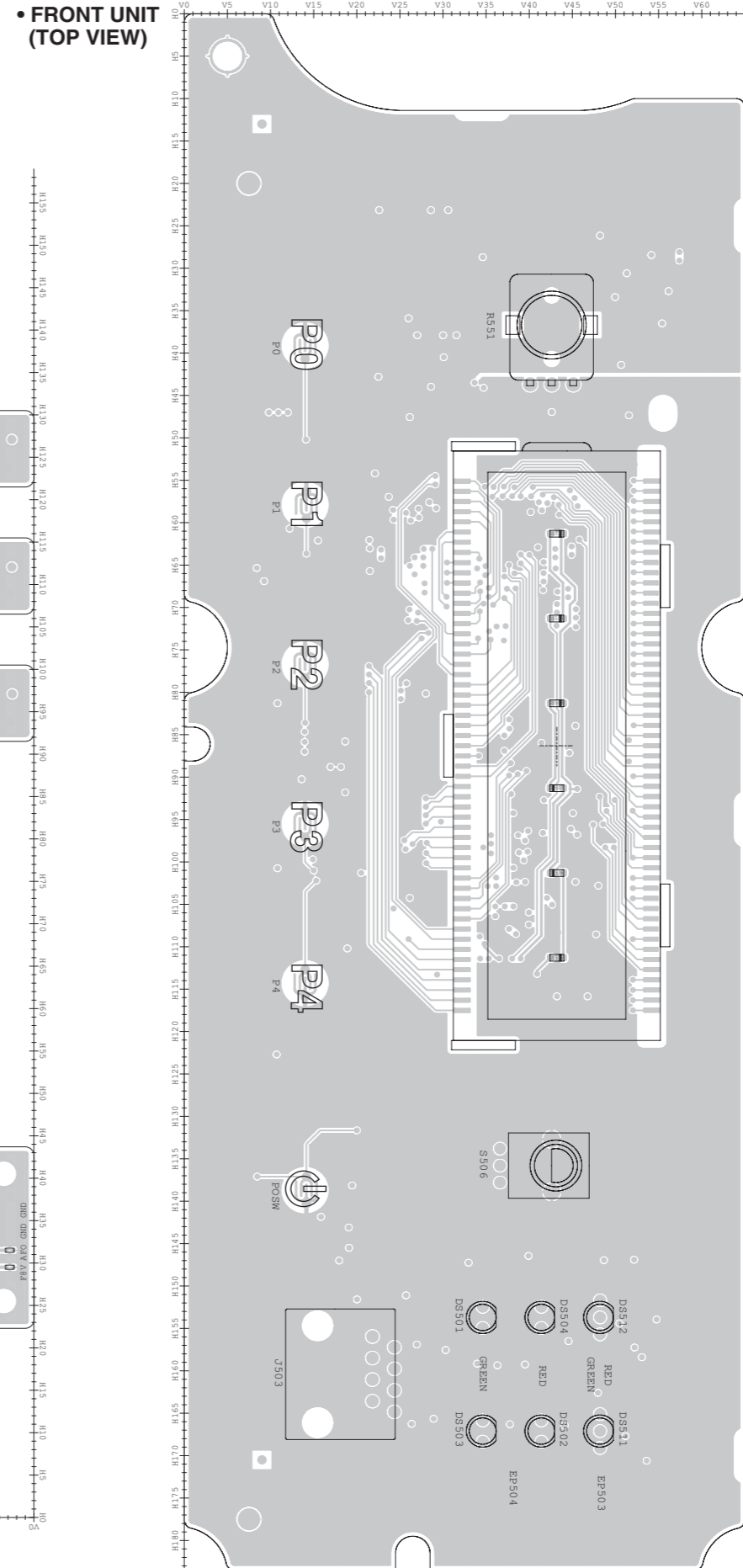

• CONNECT UNIT (TOP VIEW)

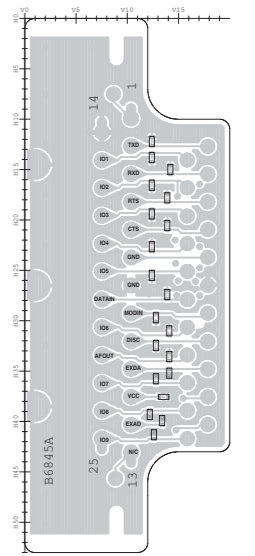

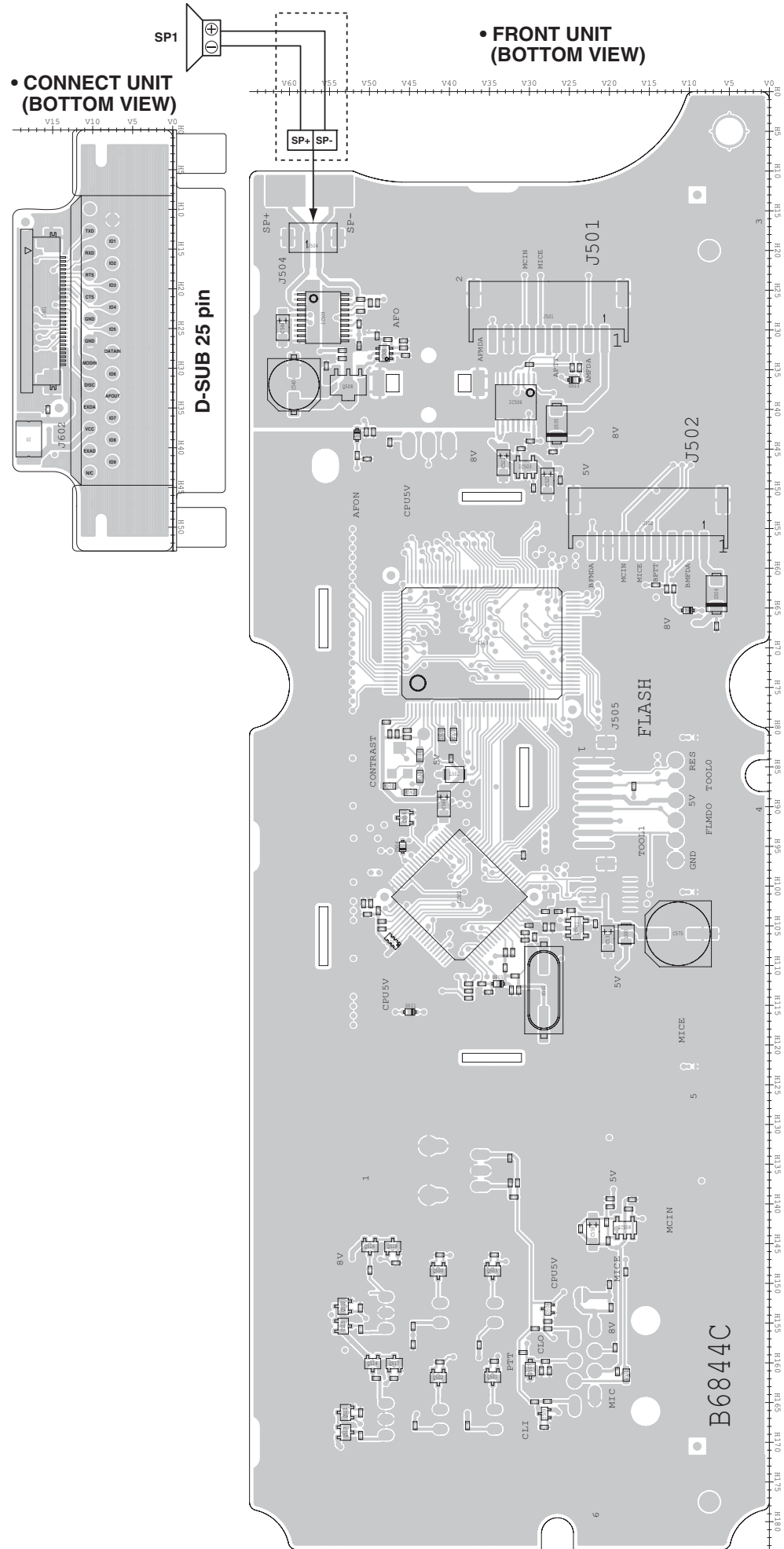

The combination of this side and the bottom side shows the board layout in the same configuration as the actual P.C.Board.

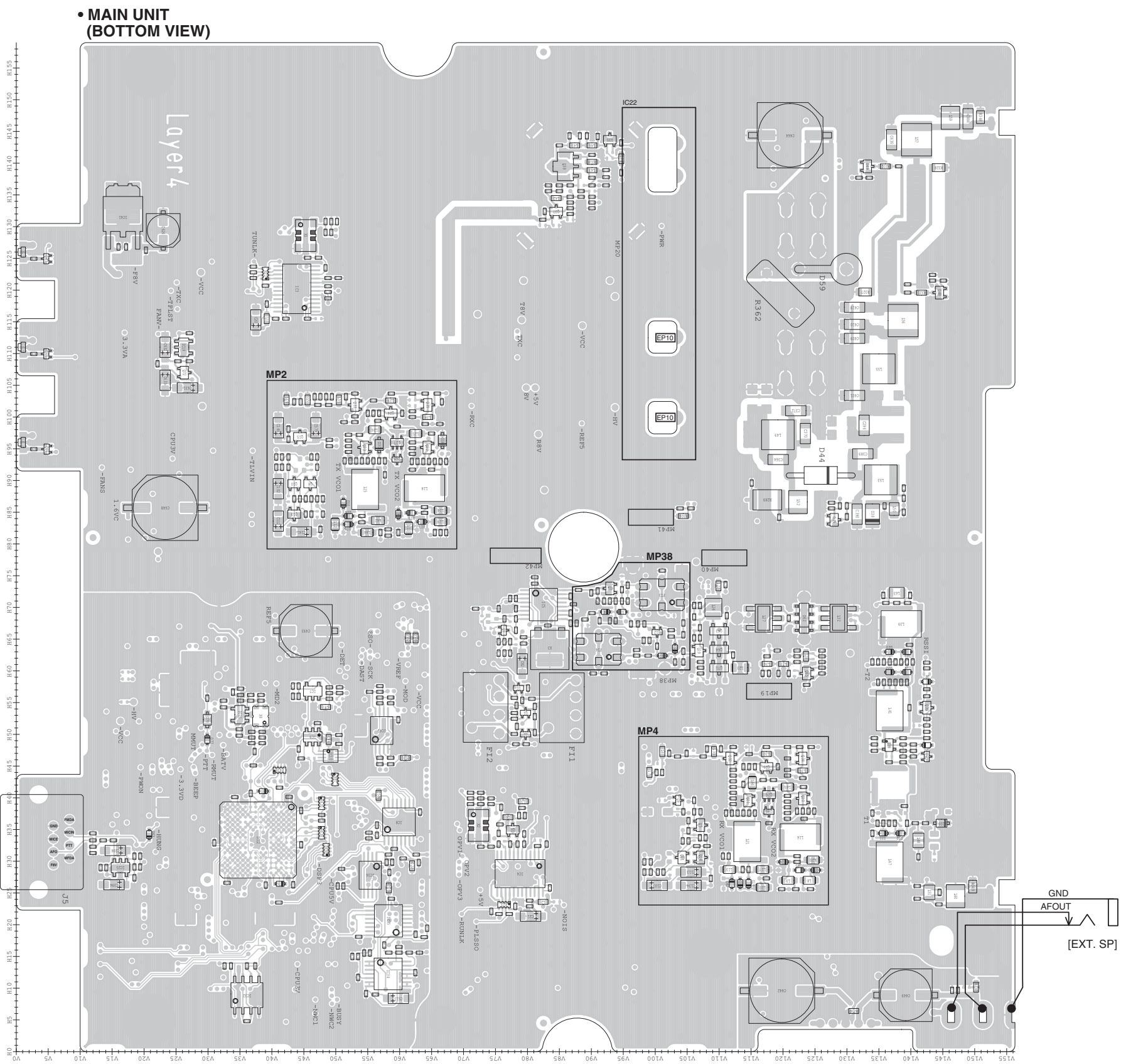

VOLTAGE DIAGRAM

FRONT UNIT

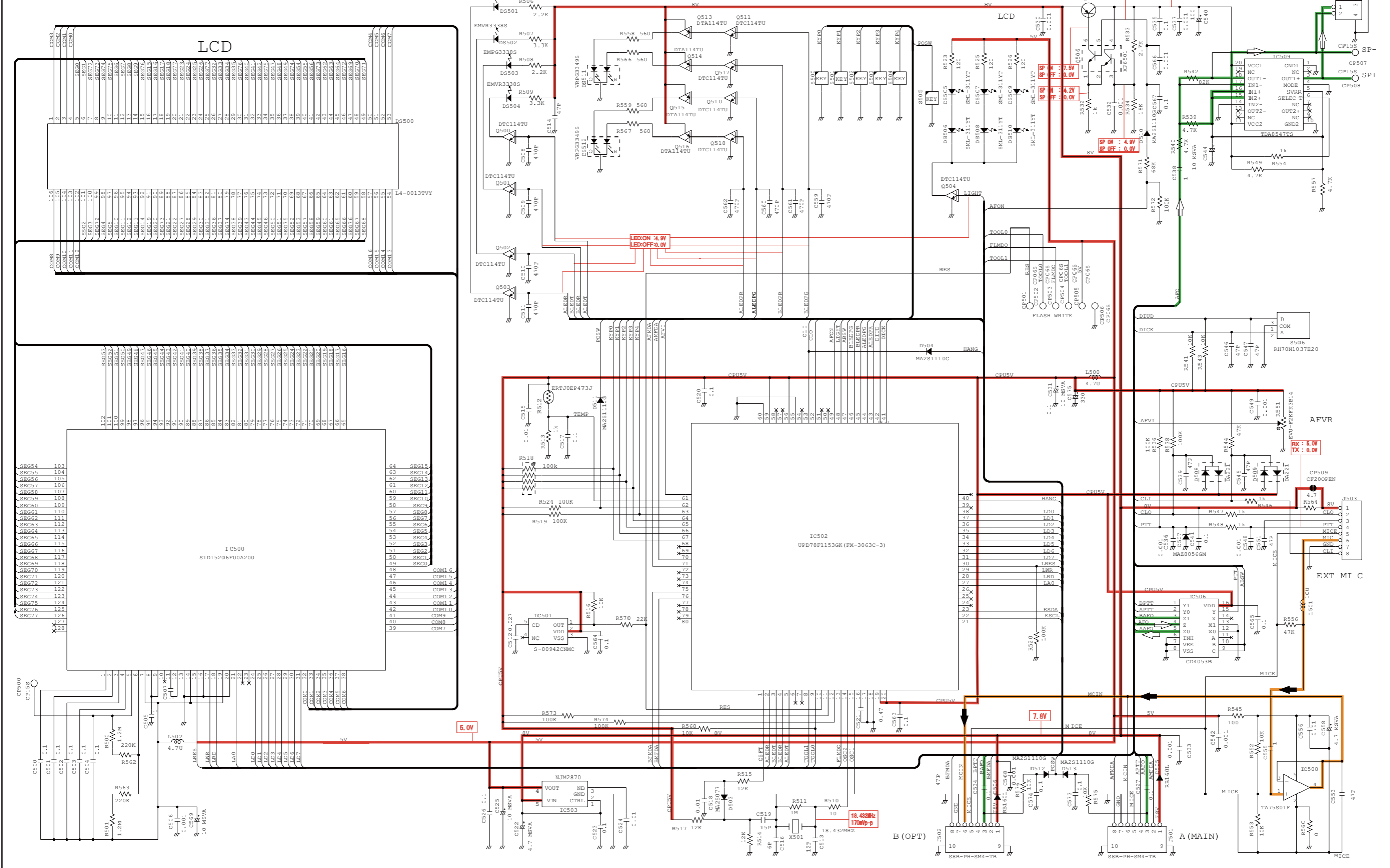

*; Refer to "PARTS LIST."

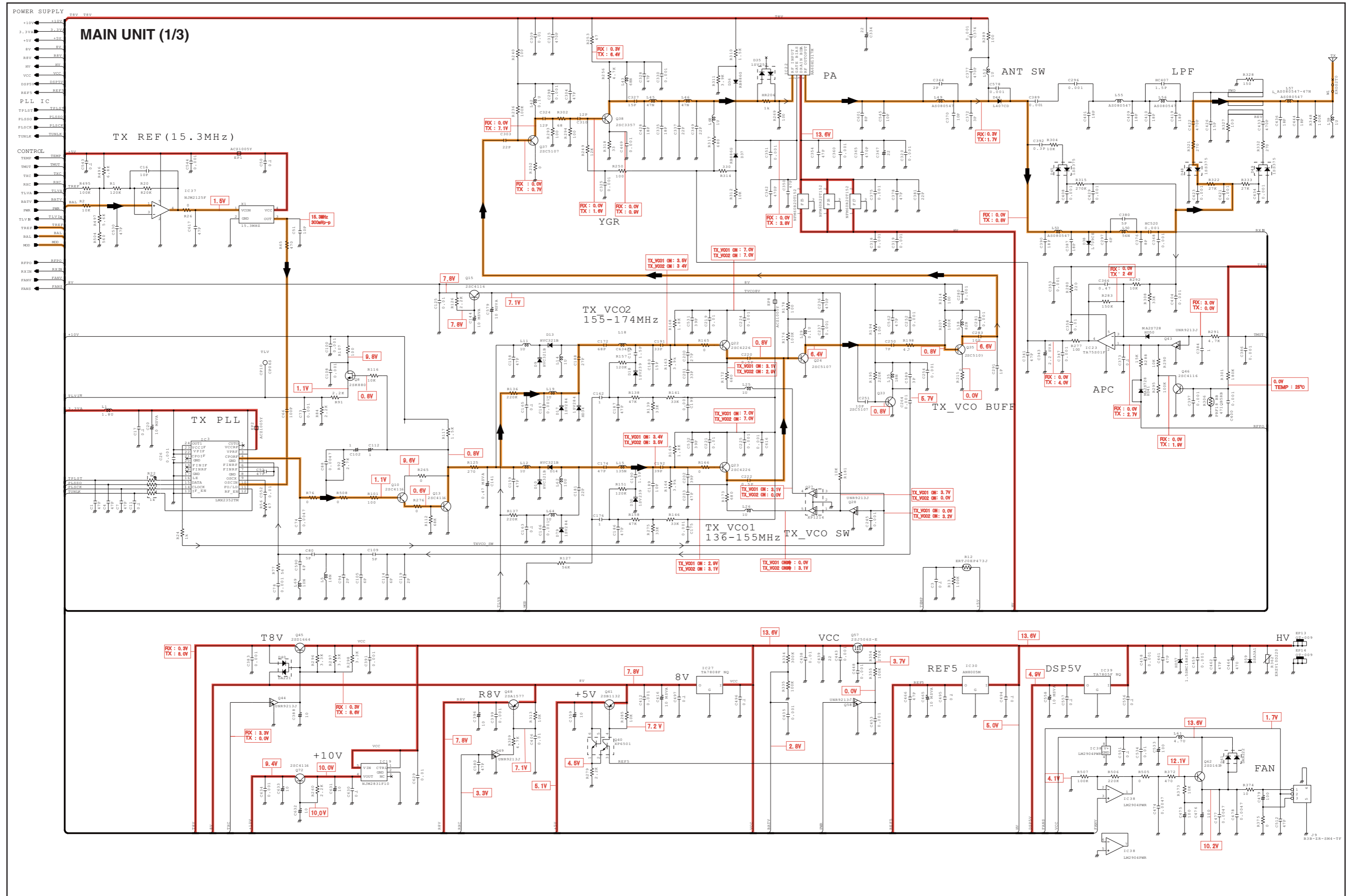

*; Refer to "PARTS LIST."

MAIN UNIT (2/3)

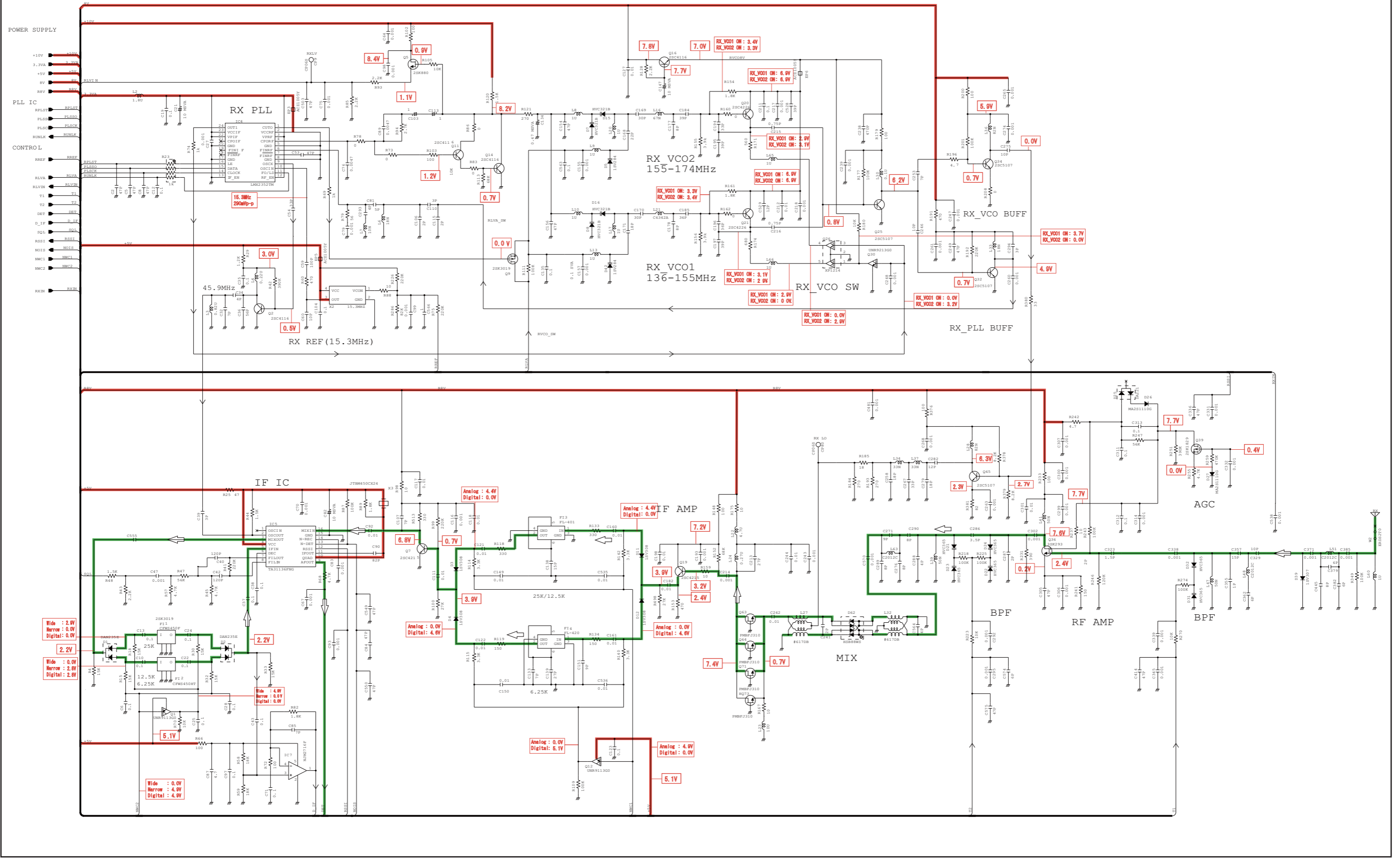

*; Refer to "PARTS LIST."

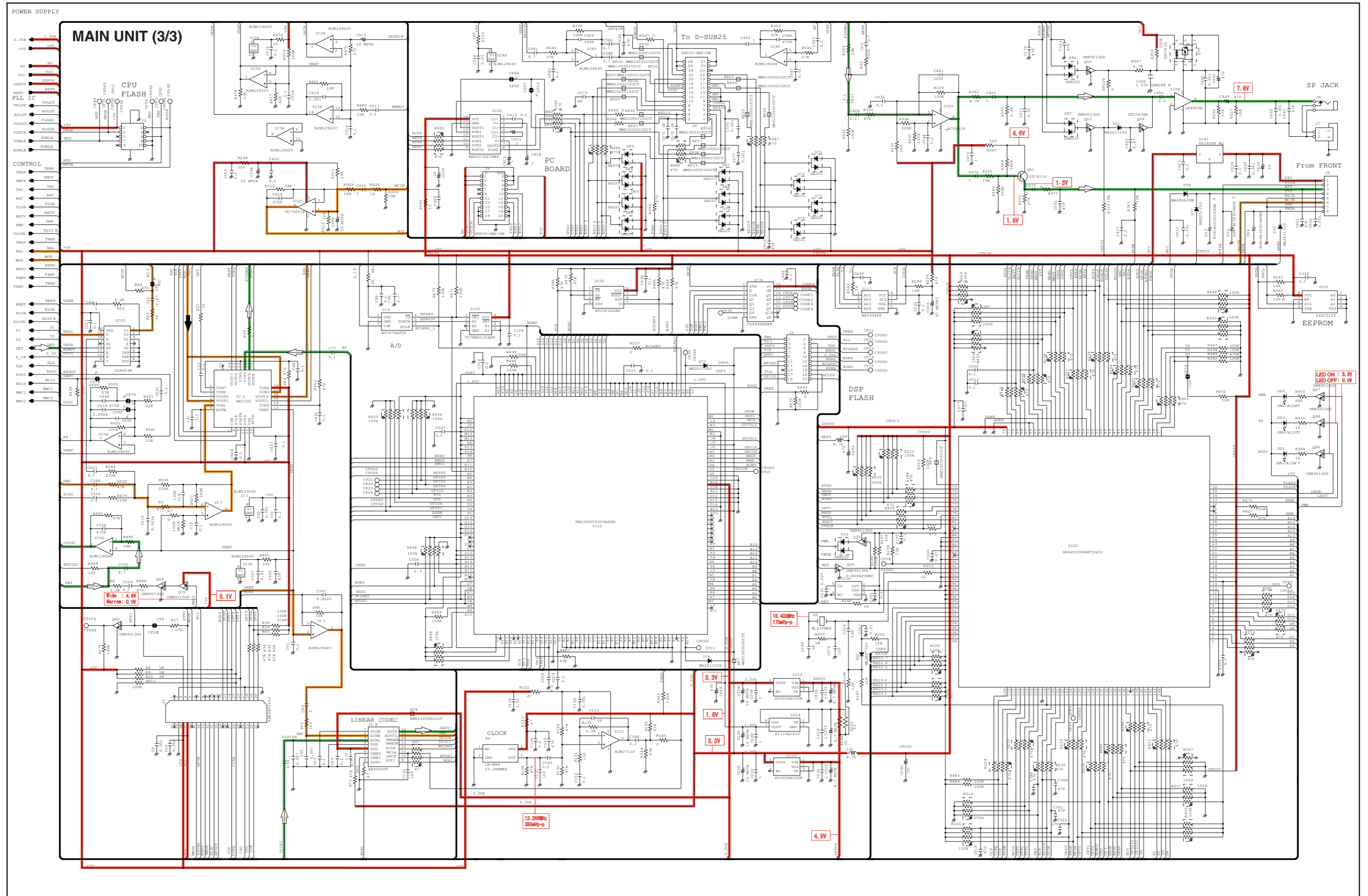

*; Refer to "PARTS LIST."

Jun. 2009



SERVICE MANUAL ADDENDUM

IC-FR5000 IC-FR5100

CONTENTS

REPLACEMENT PAGES	6-4, 6-5
PARTS LIST	1
VOLTAGE DIAGRAM	10

WHOLE PROCEDURE OF THE ADJUSTMENT

- ① Connect the repeater and PC with the JIG cable (see the page 6-2).
- ② Turn the repeater power ON.
- ③ Boot up 'CS-FR5000.'
- ④ Set the [Digital Function] to "Enable."

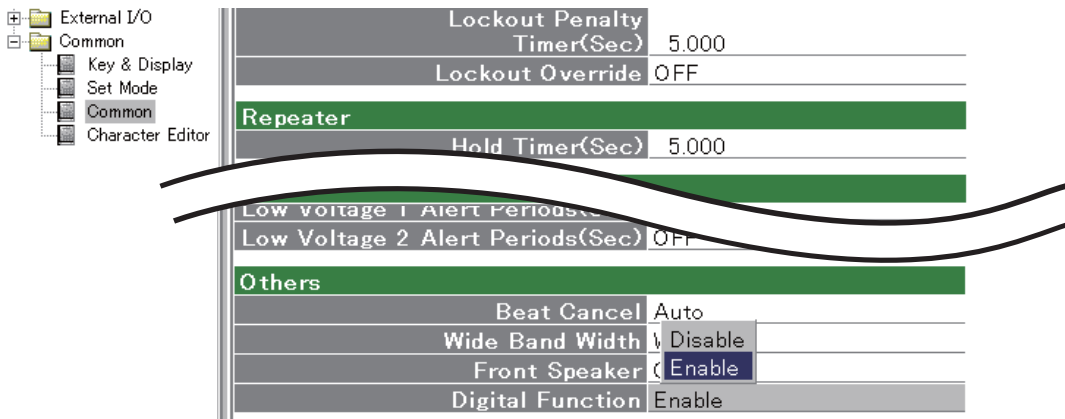

- ⑤ Click  or [Read ← TR] in the [Adjust] menu to open the "Adjust Utility" window (see the page 6-6).

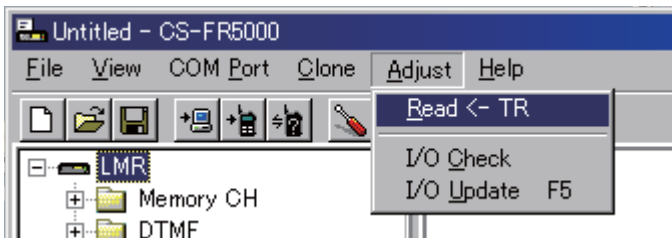

If the window below appears, the utility is password-protected. Enter the password to open the "Adjust Utility" window.

Enter Password for Adjust Read

OK
Cancel

- ⑥ Set or modify adjustment values as specified in the guidances on the pages 6-6 to 6-9.

***For [FR5100]:**

Set the [Wide Band Width] to "Middle" when adjust "ANALOG DEVIATION" in Middle mode.

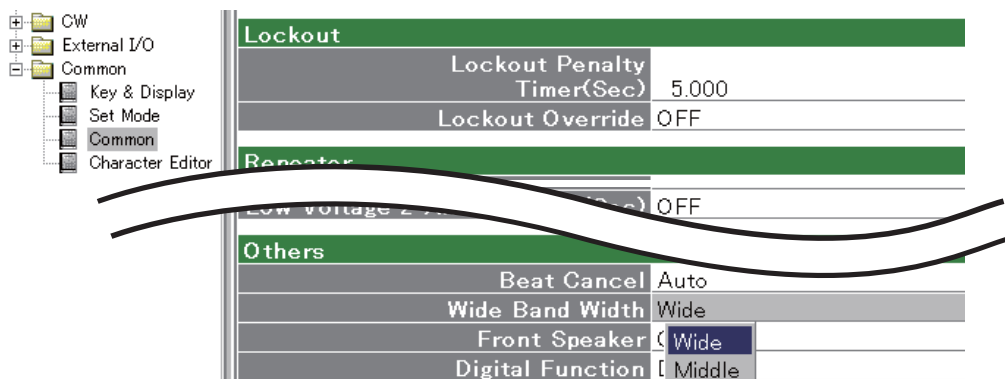

ADJUST UTILITY WINDOW

Adjust Utility			
Setting			
	CH No.	1	Band0 fL
	RX Freq.		
	TX Freq.		
	RF Power.		Low1
	W/N		Wide
	CH Type		RX=Analog TX=Analog
Mode setting	TX Mode	1	Analog Voice
	RX Mode	1	Analog
	AF Volume	0	[-----]
Adjust			
TX output power	Power (Hi)	185	[#####-----]
	Power (L2)	131	[#####-----]
	Power (L1)	88	[#####-----]
Analog deviation	MOD (Wide)	210	[#####-----]
	MOD (Mid)	135	[#####-----]
	MOD (Narrow)	95	[#####-----]
	MOD (Digital)	156	[#####-----]
CTCSS/DTCS deviation	CTCSS/DTCS	148	[#####-----]
	S.Tone	75	[#####-----]
Squelch	SQL	121	[#####-----]
Expert			
TX frequency	RX REF	154	[#####-----]
	TX REF	131	[#####-----]
Lock volatge (Preset)	RX LVA L	79	[#####-----] [Enter] to Sweep
	RX LVA H	126	[#####-----] [Enter] to Sweep
	TX LVA L	79	[#####-----] [Enter] to Sweep
	TX LVA H	158	[#####-----] [Enter] to Sweep
Lock volatge (Adjustment)	LV (RX L)	36	0.70V
	LV (RX H)	36	0.70V
	LV (TX L)	36	0.70V
	LV (TX H)	36	0.70V
S-meter	RSSI	86	[Enter] to Capture
Modulation balance	BAL	101	[#####-----]
	BAL Offset (High)	-28	[#####-----]
Modulation balance (High)	PWR Hi Slant Band 0	-2	[#####-----] 349.800000 - 358.199999 MHz
	PWR Hi Slant Band 1	-2	[#####-----] 358.200000 - 366.599999 MHz
	PWR Hi Slant Band 2	-2	[#####-----] 366.600000 - 374.999999 MHz
	PWR Hi Slant Band 4	-7	[#####-----] 383.400000 - 391.799999 MHz
	PWR Hi Slant Band 5	-6	[#####-----] 391.800000 - 400.199999 MHz
	PWR Hi Slant Band 6	0	[#####-----] 400.200000 - 408.599999 MHz
	PWR L2 Slant Band 0	-1	[#####-----] 349.800000 - 358.199999 MHz
	PWR L2 Slant Band 1	-2	[#####-----] 358.200000 - 366.599999 MHz
	PWR L2 Slant Band 2	-2	[#####-----] 366.600000 - 374.999999 MHz
	PWR L2 Slant Band 3	-7	[#####-----] 375.000000 - 383.399999 MHz
	PWR L2 Slant Band 4	-6	[#####-----] 383.400000 - 391.799999 MHz
	PWR L2 Slant Band 5	-6	[#####-----] 391.800000 - 400.199999 MHz
	PWR L2 Slant Band 6	0	[#####-----] 400.200000 - 408.599999 MHz
	PWR L1 Slant Band 0	-1	[#####-----] 349.800000 - 358.199999 MHz
	PWR L1 Slant Band 1	-1	[#####-----] 358.200000 - 366.599999 MHz
	PWR L1 Slant Band 2	-2	[#####-----] 366.600000 - 374.999999 MHz
	PWR L1 Slant Band 3	-7	[#####-----] 375.000000 - 383.399999 MHz
	PWR L1 Slant Band 4	-6	[#####-----] 383.400000 - 391.799999 MHz
PWR L1 Slant Band 5	-5	[#####-----] 391.800000 - 400.199999 MHz	
PWR L1 Slant Band 6	0	[#####-----] 400.200000 - 408.599999 MHz	
Digital deviation	MOD Slant Band 0	-9	[#####-----] 349.800000 - 358.199999 MHz
	MOD Slant Band 1	-11	[#####-----] 358.200000 - 366.599999 MHz
	MOD Slant Band 2	-11	[#####-----] 366.600000 - 374.999999 MHz
	MOD Slant Band 3	5	[#####-----] 375.000000 - 383.399999 MHz
	MOD Slant Band 4	2	[#####-----] 383.400000 - 391.799999 MHz
	MOD Slant Band 5	1	[#####-----] 391.800000 - 400.199999 MHz
	MOD Slant Band 6	0	[#####-----] 400.200000 - 408.599999 MHz
Receive sensitivity (Band center)	MOD Offset (High)	7	[#####-----]
	BPF C ALL		[Enter] to Sweep
Receive sensitivity (Band high)	BPF T1 C	87	[#####-----] [Enter] to Sweep
	BPF T2 C	118	[#####-----] [Enter] to Sweep
	BPF L ALL		[Enter] to Sweep
	BPF T1 L	109	[#####-----] [Enter] to Sweep
	BPF T2 L	42	[#####-----] [Enter] to Sweep
	BPF H ALL		[Enter] to Sweep
*Password setting	BPF T1 H	70	[#####-----] [Enter] to Sweep
	BPF T2 H	52	[#####-----] [Enter] to Sweep
	Password		

*Refer to the help file of the CS-FR5000 CLONING SOFTWARE for setting details.

[MAIN UNIT]

Table with columns: REF NO., PARTS NO., DESCRIPTION, M., H/V LOCATION. Contains 48 rows of component data.

[MAIN UNIT]

Table with columns: REF NO., PARTS NO., DESCRIPTION, M., H/V LOCATION. Contains 48 rows of component data.

M.=Mounted side (T: Mounted on the Top side, B: Mounted on the Bottom side) S.=Surface mount

[MAIN UNIT]

Table with columns: REF NO., PARTS NO., DESCRIPTION, M., H/V LOCATION. Contains part data for C387 to C508.

[MAIN UNIT]

Table with columns: REF NO., PARTS NO., DESCRIPTION, M., H/V LOCATION. Contains part data for C509 to C649.

M.=Mounted side (T: Mounted on the Top side, B: Mounted on the Bottom side) S.=Surface mount

[MAIN UNIT]

REF NO.	PARTS NO.	DESCRIPTION	M.	H/V LOCATION
J1	6510026770	S.CON AXK540147YG	T	23.1/63.7
J2	6510023092	S.CON 20FLT-SM2-TB(LF)(SN)(M)	T	14.8/15.6
J4	6510023511	S.CON 28FLT-SM2-TB(LF)(SN)	T	70.8/102
J5	6510023110	CON 3008L-8P8C <KIN>		
J6	6450000140	CON HSJ0807-01-010		
J8	6510023092	S.CON 20FLT-SM2-TB(LF)(SN)(M)	T	59.1/15.6
J9	6510019371	S.CON B3B-ZR-SM4-TF(LF)(SN)	T	94.6/14.3
J10	6510004910	CON NR-DS-E 01 <NIP>		
J11	6510004910	CON NR-DS-E 01 <NIP>		
DS1	5040002961	S.LED SML-A12MT T86J	B	96/1.1
DS2	5040002961	S.LED SML-A12MT T86J	B	126/1.1
DS3	5040003000	S.LED SML-A12UT-T86	B	111/1.1
MF1	2710000870	FAN AFB0512HB-7X22 <USE>-HK		
W1	7120000470	JUM ERDS2T0		
W2	7120000470	JUM ERDS2T0		
W4	8900017520	CAB OPC-1783		
EP1	6910015370	S.BEA ACZ1005Y-102-T	B	129.1/48.4
EP2	6910015370	S.BEA ACZ1005Y-102-T	B	115.5/45.6
EP3	6910015370	S.BEA ACZ1005Y-102-T	B	32.4/81.6
EP4	6910016330	S.BEA MMZ1005S 601CT-S	B	30.4/60.5
EP5	6910015370	S.BEA ACZ1005Y-102-T	B	39/74.3
EP6	6910015370	S.BEA ACZ1005Y-102-T	T	38.5/108.3
EP7	6910016330	S.BEA MMZ1005S 601CT-S	B	40.7/36.7
EP8	6910015370	S.BEA ACZ1005Y-102-T	B	95.4/49
EP9	6910016330	S.BEA MMZ1005S 601CT-S	T	48.8/39.3
EP10	6910011560	BEA HF70BB4.5X5X1.6		
EP13	6910011330	TER OT-009 M3		
EP14	6910011330	TER OT-009 M3		
EP16	6910018460	S.BEA MMZ1005Y102C-T	T	64.1/105
EP17	6910018460	S.BEA MMZ1005Y102C-T	T	65.1/105
EP18	6910018460	S.BEA MMZ1005Y102C-T	T	66.1/105
EP19	6910018460	S.BEA MMZ1005Y102C-T	T	66.1/106.8
EP20	6910018460	S.BEA MMZ1005Y102C-T	T	62.8/98.7
EP21	6910018460	S.BEA MMZ1005Y102C-T	T	62.8/99.6
EP22	6910018460	S.BEA MMZ1005Y102C-T	T	74.1/105
EP23	6910018460	S.BEA MMZ1005Y102C-T	T	73.2/105
EP24	6910018460	S.BEA MMZ1005Y102C-T	T	72.3/105
EP25	6910018460	S.BEA MMZ1005Y102C-T	T	71.1/105
EP26	6910018460	S.BEA MMZ1005Y102C-T	T	72.4/99
EP27	6910018460	S.BEA MMZ1005Y102C-T	T	68.2/99.1
EP28	6910018460	S.BEA MMZ1005Y102C-T	T	67.3/99.1
EP29	6910018460	S.BEA MMZ1005Y102C-T	T	65.8/99.1
EP30	6910018460	S.BEA MMZ1005Y102C-T	T	74.3/99
EP31	6910018460	S.BEA MMZ1005Y102C-T	T	70.6/98.2

[FRONT UNIT]

REF NO.	PARTS NO.	DESCRIPTION	M.	H/V LOCATION
IC500	1130009121	S.IC S1D15206F00A200	B	69.4/35.9
IC501	1110005771	S.IC S-80942CNMC-G9CT2G	B	105.3/24
IC502	1140014581	S.IC UPD78F1153GK(R)-GAK-AX (3063C-2)	B	101.3/38.7
IC503	1110005350	S.IC NJM2870F05-TE1-#FZZB	B	47.2/30.5
IC506	1140013200	S.IC CD4053BPWR	B	39.1/31.7
IC508	1110002751	S.IC TA75S01F(TE85R,F)	B	143/18
IC509	1110006770	S.IC TDA8547TS/N	B	28.4/55.8
Q500	1590001050	S.TRA DTC114TUA T106	B	148.4/41.4
Q501	1590001050	S.TRA DTC114TUA T106	B	161.8/34.6
Q502	1590001050	S.TRA DTC114TUA T106	B	161.8/41.4
Q503	1590001050	S.TRA DTC114TUA T106	B	148.4/34.6
Q504	1590001050	S.TRA DTC114TUA T106	B	91.4/45.6
Q506	1590001190	S.TRA XP6501-(TX).AB	B	32.9/48.1
Q508	1520000460	S.TRA 2SB1132 T100 R	B	36.9/52.6
Q510	1590001050	S.TRA DTC114TUA T106	B	152.8/53.2
Q511	1590001050	S.TRA DTC114TUA T106	B	166.2/53
Q513	1590001060	S.TRA DTA114TUA T106	B	168.7/53
Q514	1590001060	S.TRA DTA114TUA T106	B	160.1/49.6
Q515	1590001060	S.TRA DTA114TUA T106	B	155.3/53.2
Q516	1590001060	S.TRA DTA114TUA T106	B	145.3/49.9
Q517	1590001050	S.TRA DTC114TUA T106	B	160.1/46.9
Q518	1590001050	S.TRA DTC114TUA T106	B	145.3/47
D503	1790001261	S.DIO MA2S077G0L	B	112.3/33.9
D504	1790001251	S.DIO MA2S1110GL	B	95/45.8
D505	1790001450	S.DIO RB160L-40 TE-25	B	41.8/26.6
D506	1790001450	S.DIO RB160L-40 TE-25	B	63.2/6.6
D507	1790000951	S.ZEN MAZ8056GML	B	160.8/29.9
D508	1750000370	S.DIO DA221 TL	B	153.2/27.7
D509	1750000370	S.DIO DA221 TL	B	166.4/28.1
D510	1790001251	S.DIO MA2S1110GL	B	43.2/51.5
D511	1790001251	S.DIO MA2S1110GL	B	115.8/44.9
D512	1790001251	S.DIO MA2S1110GL	B	65.3/10.2
D513	1790001251	S.DIO MA2S1110GL	B	36.3/24.4
X501	6050012680	S.XTA CR-858(SMD-49/18.432 MHz) <JJE>	B	113.1/28.2
L500	6200002861	S.COI NLV25T-4R7J	B	106/17.9
L501	6200003640	S.COI MLF1608E 100K-T	B	161.5/17.9
L502	6200002861	S.COI NLV25T-4R7J	B	85.9/39.3
R500	7030003810	S.RES ERJ3GEYJ 125 V (1.2M)	B	83.5/43.7
R501	7030003810	S.RES ERJ3GEYJ 125 V (1.2M)	B	87.4/47.5
R506	7030007290	S.RES ERJ2GEJ 222 X (2.2K)	B	157.7/36.3
R507	7030007300	S.RES ERJ2GEJ 332 X (3.3K)	B	167.9/44.3
R508	7030007290	S.RES ERJ2GEJ 222 X (2.2K)	B	167.9/37.7
R509	7030007300	S.RES ERJ2GEJ 332 X (3.3K)	B	155.4/44.5
R510	7030005530	S.RES ERJ2GEJ 100 X (10)	B	106.8/30.5
R511	7030005160	S.RES ERJ2GEJ 105 X (1M)	B	105.8/30.5
R512	7510001730	S.THE ERTJOEP 473J	B	103.1/48.9
R513	7030005120	S.RES ERJ2GEJ 102 X (1K)	B	102.2/49.8
R514	7030008010	S.RES ERJ2GEJ 123 X (12K)	B	113.1/32.2
R515	7030008010	S.RES ERJ2GEJ 123 X (12K)	B	112.3/35.9
R516	7030005050	S.RES ERJ2GEJ 103 X (10K)	B	103.2/26.4
R517	7030008010	S.RES ERJ2GEJ 123 X (12K)	B	110.3/33
R518	7410001140	S.ARR EXB28V104JX	B	106.9/47.1
R519	7030005090	S.RES ERJ2GEJ 104 X (100K)	B	105.4/48.4
R520	7030005090	S.RES ERJ2GEJ 104 X (100K)	B	96.1/30.7
R523	7030005710	S.RES ERJ2GEJ 121 X (120)	B	114.1/37.6
R524	7030005090	S.RES ERJ2GEJ 104 X (100K)	B	104.4/48.4
R525	7030005710	S.RES ERJ2GEJ 121 X (120)	B	113.2/37.6
R526	7030005710	S.RES ERJ2GEJ 121 X (120)	B	112.3/37.6
R532	7030005120	S.RES ERJ2GEJ 102 X (1K)	B	33.2/45.5
R533	7030009140	S.RES ERJ2GEJ 272 X (2.7K)	B	31.2/47.7
R534	7030008290	S.RES ERJ2GEJ 183 X (18K)	B	32.2/45.7
R536	7030005090	S.RES ERJ2GEJ 104 X (100K)	B	158.7/30.8
R538	7030005090	S.RES ERJ2GEJ 104 X (100K)	B	155.7/29.3
R539	7030005040	S.RES ERJ2GEJ 472 X (4.7K)	B	27.6/51.1
R540	7030005040	S.RES ERJ2GEJ 472 X (4.7K)	B	26.6/49.9
R541	7030005050	S.RES ERJ2GEJ 103 X (10K)	B	139.1/31.9
R542	7030005080	S.RES ERJ2GEJ 823 X (82K)	B	26.1/51.1
R543	7030005050	S.RES ERJ2GEJ 103 X (10K)	B	137.3/31.5
R544	7030005240	S.RES ERJ2GEJ 473 X (47K)	B	164.9/29.3
R545	7030004980	S.RES ERJ2GEJ 101 X (100)	B	140.3/19.9
R546	7030005120	S.RES ERJ2GEJ 102 X (1K)	B	164.8/27.7
R547	7030005120	S.RES ERJ2GEJ 102 X (1K)	B	155.7/27.7
R548	7030005120	S.RES ERJ2GEJ 102 X (1K)	B	159.8/28
R549	7030005040	S.RES ERJ2GEJ 472 X (4.7K)	B	32/51.3
R551	7210003050	VAR EVU-F2KFK3 B14 (10KB)		
R552	7030005050	S.RES ERJ2GEJ 103 X (10K)	B	142.3/20.3
R553	7030005050	S.RES ERJ2GEJ 103 X (10K)	B	144.6/20.1
R554	7030005120	S.RES ERJ2GEJ 102 X (1K)	B	32.6/53.4
R556	7030005240	S.RES ERJ2GEJ 473 X (47K)	B	161.1/19
R557	7030005040	S.RES ERJ2GEJ 472 X (4.7K)	B	29.2/51.3
R558	7030008370	S.RES ERJ2GEJ 561 X (560)	B	169.1/51.1
R559	7030008370	S.RES ERJ2GEJ 561 X (560)	B	155.7/51
R560	7030010040	S.RES ERJ2GEJ-JPW	B	139.4/17.1
R562	7030003720	S.RES ERJ3GEYJ 224 V (220K)	B	86.2/43.7
R563	7030003720	S.RES ERJ3GEYJ 224 V (220K)	B	88.2/44.9
R564	7030009320	S.RES ERJ2GEJ 4R7 X (4.7)	B	153/19.8
R566	7030008370	S.RES ERJ2GEJ 561 X (560)	B	161.9/49.1
R567	7030008370	S.RES ERJ2GEJ 561 X (560)	B	148.3/49.9
R568	7030005050	S.RES ERJ2GEJ 103 X (10K)	B	87.4/16.9
R570	7030005220	S.RES ERJ2GEJ 223 X (22K)	B	103/24.8
R571	7030005070	S.RES ERJ2GEJ 683 X (68K)	B	45.8/51.5
R572	7030005090	S.RES ERJ2GEJ 104 X (100K)	B	46.2/50.3
R573	7030005090	S.RES ERJ2GEJ 104 X (100K)	B	108.3/33

M.=Mounted side (T: Mounted on the Top side, B: Mounted on the Bottom side)
S.=Surface mount

[FRONT UNIT]

REF NO.	PARTS NO.	DESCRIPTION	M.	H/V LOCATION
R574	7030005090	S.RES ERJ2GEJ 104 X (100K)	B	108.3/32.1
R575	7030005050	S.RES ERJ2GEJ 103 X (10K)	B	34.7/24.6
R576	7030005050	S.RES ERJ2GEJ 103 X (10K)	B	62.6/12.8
C500	4030016930	S.CER ECJ0EB1A104K	B	79.3/47.9
C501	4030016930	S.CER ECJ0EB1A104K	B	80.8/47.4
C502	4030016930	S.CER ECJ0EB1A104K	B	80.8/46.5
C503	4030016930	S.CER ECJ0EB1A104K	B	80.4/45.3
C504	4030016930	S.CER ECJ0EB1A104K	B	81.3/45.3
C505	4030017490	S.CER C1608 JB 1A 105K-T	B	80.9/41
C506	4030017460	S.CER ECJ0EB1E102K	B	83.9/39.8
C507	4030017490	S.CER C1608 JB 1A 105K-T	B	80.9/39.5
C508	4030017730	S.CER ECJ0EB1E471K	B	146.4/41.2
C509	4030017730	S.CER ECJ0EB1E471K	B	159.8/34.4
C510	4030017730	S.CER ECJ0EB1E471K	B	159.9/41.2
C511	4030017730	S.CER ECJ0EB1E471K	B	146.4/34.4
C512	4030017030	S.CER ECJ0EB1A273K	B	104.7/21.7
C513	4030017630	S.CER ECJ0EC1H120J	B	106.4/29.3
C514	4030017420	S.CER ECJ0EC1H470J	B	157.7/44.5
C515	4030016790	S.CER ECJ0EB1C103K	B	103.5/50.2
C516	4030017580	S.CER ECJ0EC1H060C	B	113.1/31.3
C517	4030016930	S.CER ECJ0EB1A104K	B	102.2/50.7
C518	4030016790	S.CER ECJ0EB1C103K	B	113.3/35.1
C519	4030017640	S.CER ECJ0EC1H150J	B	111.3/31.8
C520	4030016930	S.CER ECJ0EB1A104K	B	105.1/27.1
C521	4030018900	S.CER ECJ0EB0J474K	B	104.9/30
C522	4550006480	S.TAN TEESVA 1C 475M8R	B	46.7/33.2
C523	4030017330	S.CER ECJ0EF1C104Z	B	44.9/31
C524	4030016790	S.CER ECJ0EB1C103K	B	49.9/29.5
C525	4550006250	S.TAN TEESVA 1A 106M8R	B	49/27.7
C526	4030016930	S.CER ECJ0EB1A104K	B	48.9/26.1
C527	4030016930	S.CER ECJ0EB1A104K	B	34.3/30
C530	4030017460	S.CER ECJ0EB1E102K	B	34.5/55.4
C531	4550006250	S.TAN TEESVA 1A 106M8R	B	106.6/20.2
C532	4030017460	S.CER ECJ0EB1E102K	B	31.3/45.7
C533	4030017460	S.CER ECJ0EB1E102K	B	45.3/27
C534	4030016930	S.CER ECJ0EB1A104K	B	62.1/14.2
C535	4030016930	S.CER ECJ0EB1A104K	B	30.7/49
C536	4030017460	S.CER ECJ0EB1E102K	B	161/28.5
C537	4030017460	S.CER ECJ0EB1E102K	B	33.6/53.4
C538	4030018860	S.CER ECJ0EB0J105K	B	26.6/49
C539	4030017420	S.CER ECJ0EC1H470J	B	154.8/27.7
C540	4510008590	S.ELE EEE1AA101SP	B	36.9/59.4
C541	4030017330	S.CER ECJ0EF1C104Z	B	150.1/20
C542	4030017460	S.CER ECJ0EB1E102K	B	139.3/19.9
C544	4550006250	S.TAN TEESVA 1A 106M8R	B	29.7/60.8
C545	4030017420	S.CER ECJ0EC1H470J	B	168.1/28.1
C546	4030017420	S.CER ECJ0EC1H470J	B	137.3/32.4
C547	4030017420	S.CER ECJ0EC1H470J	B	134.2/32.4
C548	4030017460	S.CER ECJ0EB1E102K	B	161/27.5
C549	4030017460	S.CER ECJ0EB1E102K	B	44.1/47.4
C551	4030017420	S.CER ECJ0EC1H470J	B	158.1/19.3
C553	4030017420	S.CER ECJ0EC1H470J	B	140.6/17.6
C555	4030018860	S.CER ECJ0EB0J105K	B	148.5/17.9
C556	4030016790	S.CER ECJ0EB1C103K	B	143.1/23.6
C558	4550006480	S.TAN TEESVA 1C 475M8R	B	143.5/22
C559	4030017730	S.CER ECJ0EB1E471K	B	166.3/51.1
C560	4030017730	S.CER ECJ0EB1E471K	B	153.1/51.1
C561	4030017730	S.CER ECJ0EB1E471K	B	161.9/46.9
C562	4030017730	S.CER ECJ0EB1E471K	B	147.4/46.6
C563	4030016930	S.CER ECJ0EB1A104K	B	105.1/28
C564	4030016930	S.CER ECJ0EB1A104K	B	103.2/28
C565	4030016930	S.CER ECJ0EB1A104K	B	44/29.9
C566	4030017460	S.CER ECJ0EB1E102K	B	42.8/49.5
C567	4030016930	S.CER ECJ0EB1A104K	B	42.8/50.4
C568	4030017460	S.CER ECJ0EB1E102K	B	67.3/6.6
C569	4550006250	S.TAN TEESVA 1A 106M8R	B	89.6/40.7
C573	4030016930	S.CER ECJ0EB1A104K	B	34.7/23.7
C574	4030016930	S.CER ECJ0EB1A104K	B	62.6/11.9
C575	4510009020	S.ELE EEE0JA331P	B	106/11.4
J501	6510019121	S.CON S8B-PH-SM4-TB(LF)(SN)	B	26.9/27.5
J502	6510019121	S.CON S8B-PH-SM4-TB(LF)(SN)	B	52.9/15.1
J503	6450002210	CON 3017-8821 <KIN>		
J504	6510014961	S.CON B2B-ZR-SM4-TF(LF)(SN)	B	18.4/57
DS500	5030002811	LCD L4-0013TVVY-2		
DS501	5040002710	LED EMPG3338S		
DS502	5040002720	LED EMVR3338S		
DS503	5040002710	LED EMPG3338S		
DS504	5040002720	LED EMVR3338S		
DS505	5040002310	S.LED SML-311YTT86	T	111.2/43.2
DS506	5040002310	S.LED SML-311YTT86	T	101.3/43.2
DS507	5040002310	S.LED SML-311YTT86	T	91.3/43.2
DS508	5040002310	S.LED SML-311YTT86	T	81.2/43.1
DS509	5040002310	S.LED SML-311YTT86	T	71.3/43.2
DS510	5040002310	S.LED SML-311YTT86	T	61.3/43.2
DS511	5040002150	LED VRPG3349S-734		
DS512	5040002150	LED VRPG3349S-734		
S506	2250000511	ENC RH70N1037E20-13F-2781		
SP501	2510001221	SPE C052SB500-14 <OSC>		
W501	8900011800	CAB OPC-1199		
W502	89000117540	CAB OPC-1785		
EP501	8930065150	LCD SRCN-2781-SP-N-W (SHJ)		

[FRONT UNIT]

REF NO.	PARTS NO.	DESCRIPTION	M.	H/V LOCATION
EP503	6910019600	SPA LM-5		
EP504	6910019610	SPA LM-7 (SPACER)		

M.=Mounted side (T: Mounted on the Top side, B: Mounted on the Bottom side)
S.=Surface mount

[CONNECT UNIT]

REF NO.	PARTS NO.	DESCRIPTION	M.	H/V LOCATION
C601	4030017420	S.CER ECJ0EC1H470J	T	13.8/12.4
C602	4030017400	S.CER ECJ0EC1H220J	T	12.2/12.4
C603	4030017420	S.CER ECJ0EC1H470J	T	16.5/12.4
C604	4030017400	S.CER ECJ0EC1H220J	T	15/14.2
C605	4030017420	S.CER ECJ0EC1H470J	T	17.8/13.9
C606	4030017420	S.CER ECJ0EC1H470J	T	19.4/12.4
C607	4030017420	S.CER ECJ0EC1H470J	T	20.5/13.9
C608	4030017420	S.CER ECJ0EC1H470J	T	22.6/12.4
C609	4030017420	S.CER ECJ0EC1H470J	T	25.5/12.4
C610	4030017420	S.CER ECJ0EC1H470J	T	29.7/12.8
C611	4030017420	S.CER ECJ0EC1H470J	T	31/14.1
C612	4030017420	S.CER ECJ0EC1H470J	T	32.4/12.8
C613	4030017420	S.CER ECJ0EC1H470J	T	33.5/14.1
C614	4030017420	S.CER ECJ0EC1H470J	T	35.2/14.1
C615	4030017420	S.CER ECJ0EC1H470J	T	35.7/12.8
C616	4030017420	S.CER ECJ0EC1H470J	B	35.2/15.6
C617	4030017420	S.CER ECJ0EC1H470J	T	37.5/13.5
C618	4030017420	S.CER ECJ0EC1H470J	T	39.3/12.2
C619	4030017420	S.CER ECJ0EC1H470J	T	39.9/13.4
C620	4030017420	S.CER ECJ0EC1H470J	T	41.3/12.6
C621	4030017420	S.CER ECJ0EC1H470J	T	27.4/13.9
J601	6510026290	S.CON IMSA-9631S-28Y921	B	22.8/16.2
J602	6510023210	CON CD6125SA1J0 <CVI>		
S1	2260003070	S.SWI MINISMDC150F/24-2	B	38.9/18
W601	8900017500	CAB OPC-1852 (P0.5,N28,L90) <TJM>		

M.=Mounted side (T: Mounted on the Top side, B: Mounted on the Bottom side)
S.=Surface mount

VOLTAGE DIAGRAM

FRONT UNIT

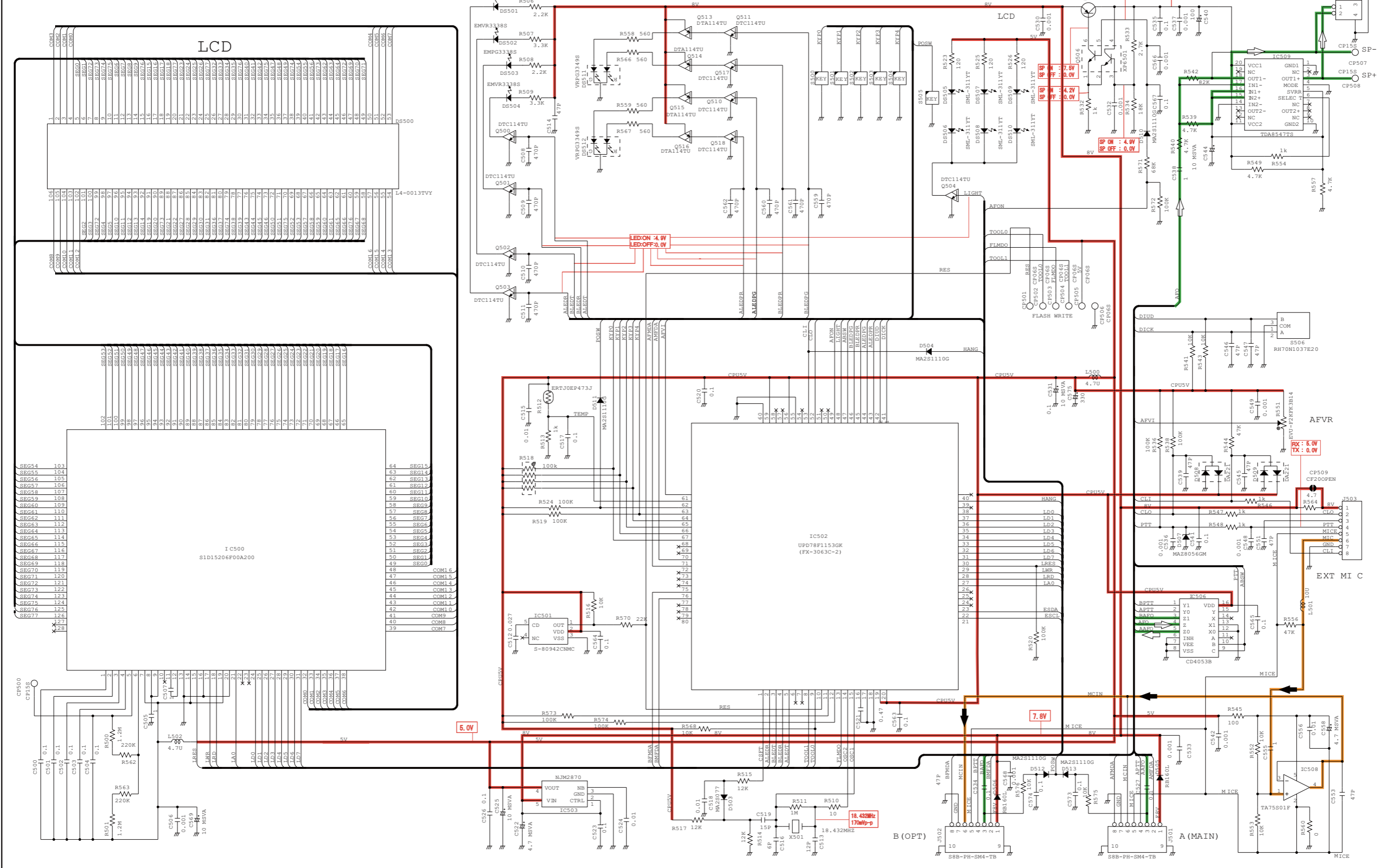

*; Refer to "PARTS LIST."

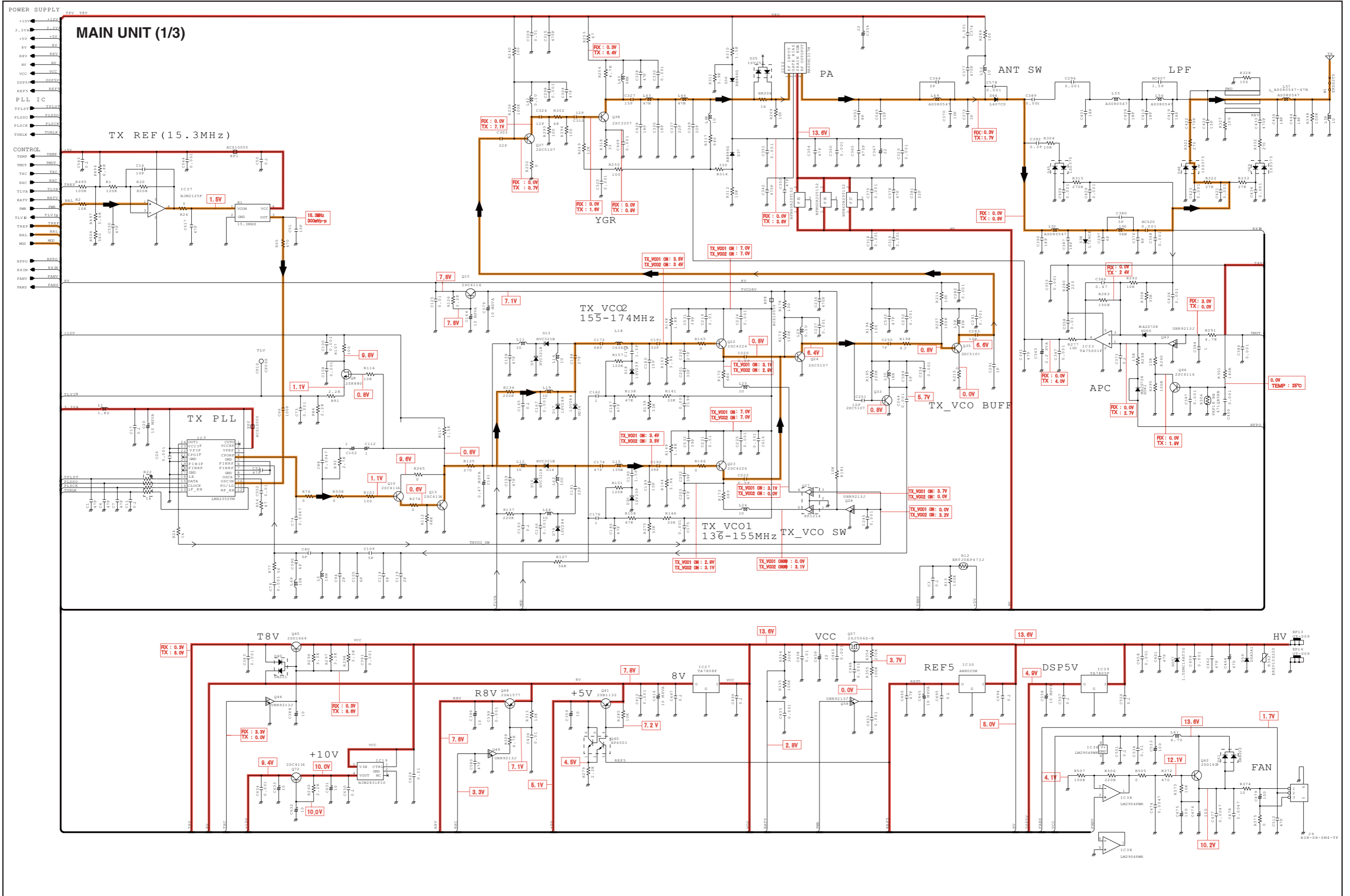

*; Refer to "PARTS LIST."

MAIN UNIT (2/3)

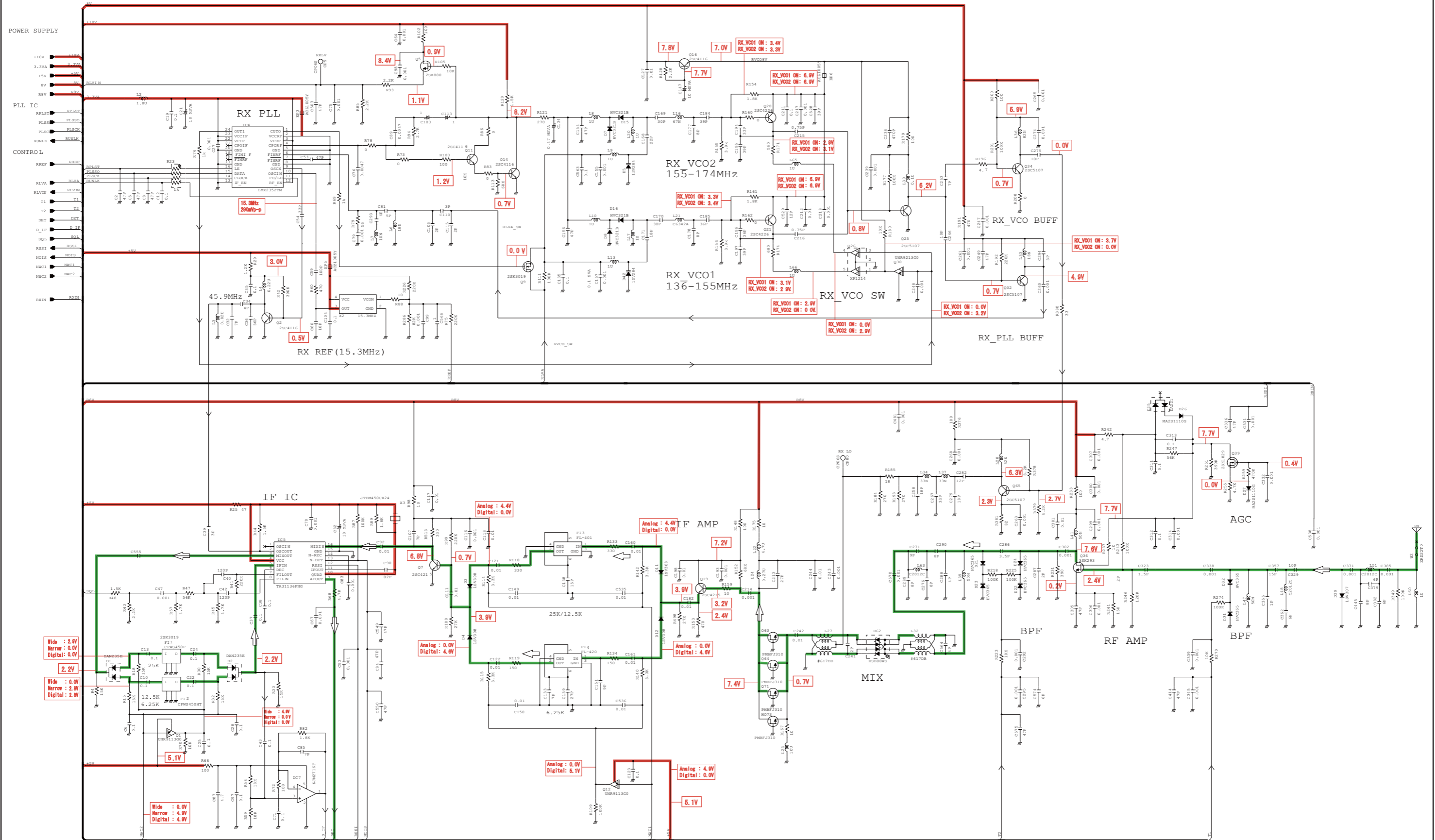

*; Refer to "PARTS LIST."

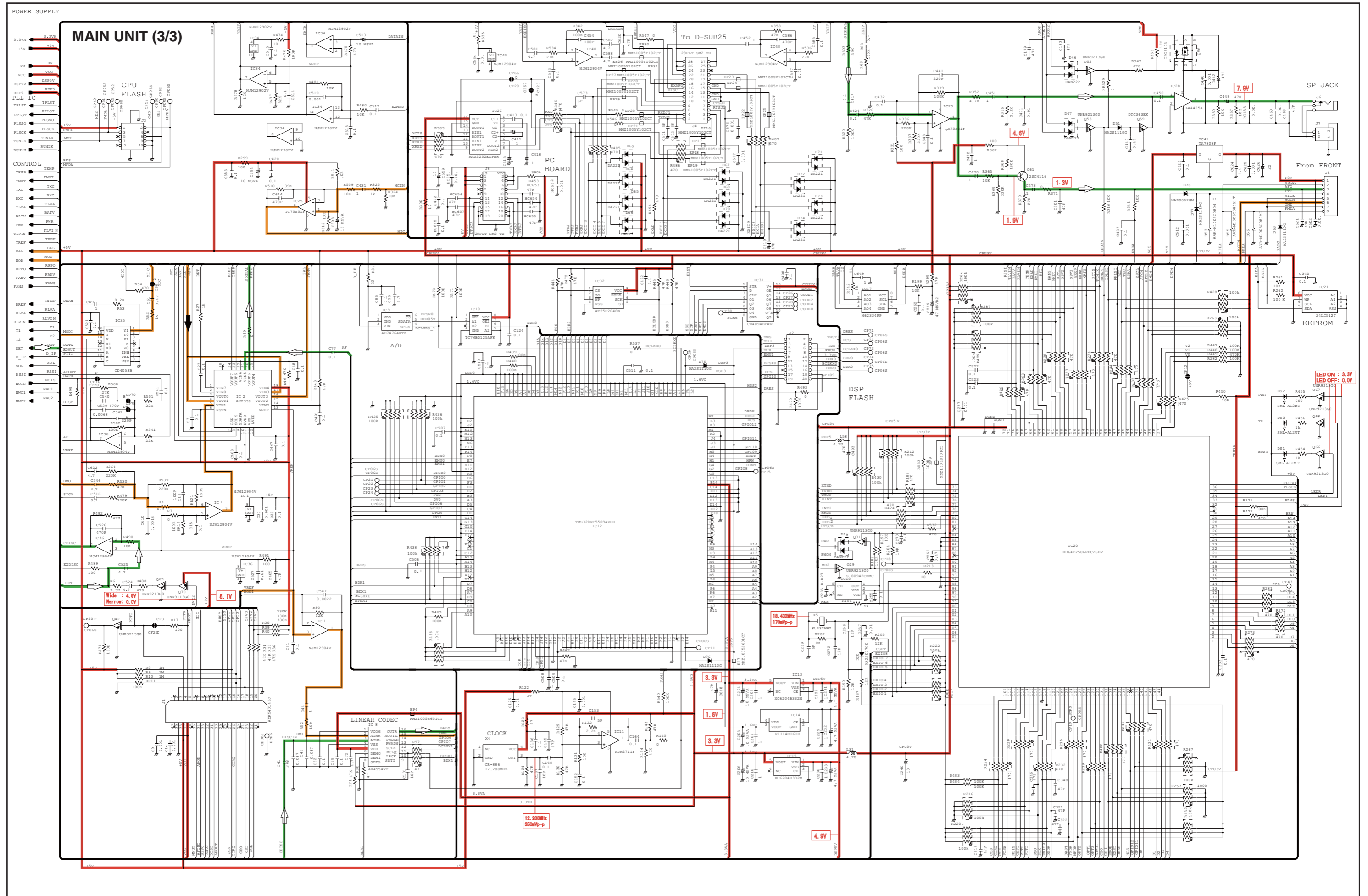

*; Refer to "PARTS LIST."

Aug. 2008



SERVICE MANUAL ADDENDUM

IC-FR5000 IC-FR5100

CONTENTS

REPLACEMENT PAGES (6-8 and 6-9)	-
PARTS LIST	1
VOLTAGE DIAGRAM	9

6-3 TRANSMIT ADJUSTMENT (continued)

- 1) Select an adjustment item using cursor or [↑] / [↓] keys of the PC's keyboard.
- 2) Set or modify the adjustment value as specified using [←] / [→] keys of the PC's keyboard, then push the [ENTER] key.

ADJUSTMENT	ADJUSTMENT CONDITION	OPERATION	ADJUSTMENT ITEM	VALUE
ANALOG DEVIATION -Preparation-	1	–	• Set the item [TX Mode] to "1."	[TX Mode] "1"
	2	• Connect a Modulation Analyzer to the TX antenna connector through an attenuator.	• Set the Modulation Analyzer as; HPF : OFF LPF : 20 kHz De-emphasis : OFF Detector : (P-P)/2	– –
	3	• Connect an Audio Generator to the MIC line through the JIG cable.	• Set the Audio Generator as; Modulation : 1050 Hz Level : 40 mVrms Waveform : Sine wave	– –
-Adjust- (Wide)	4	• CH. : 1-23 • Transmitting	1) Adjust the deviation using [←] / [→] keys of the PC's keyboard. 2) Push the [ENTER] key to store the adjust value.	[MOD (Wide)] ±4.05–4.15 kHz
(Middle) <[FR5100] only>	5	• CH. : 1-24 • [Wide Band Width] : "Middle" (see the page 6-4) • Transmitting		[MOD (Middle)] ±3.15–3.25 kHz
(Narrow)	6	• CH. : 1-25 • Transmitting		[MOD (Narrow)] ±2.05–2.15 kHz
CTCSS/DTCS DEVIATION -Preparation-	1	–	• Set the item [TX Mode] to "3."	[TX Mode] "3"
-Adjust-	2	• CH. : 1-26 • Transmitting	1) Adjust the deviation using [←] / [→] keys of the PC's keyboard. 2) Push the [ENTER] key to store the adjust value.	[CTCSS] ±0.68–0.72 kHz

6-4 RECEIVE ADJUSTMENT

- 1) Select an adjustment item using cursor or [↑] / [↓] keys of the PC's keyboard.
- 2) Set or modify the adjustment value as specified using [←] / [→] keys of the PC's keyboard, then push the [ENTER] key.

ADJUSTMENT	ADJUSTMENT CONDITION	OPERATION	ADJUSTMENT ITEM/POINT	VALUE
RECEIVE SENSITIVITY -Preparation-	1	–	• Set the item [RX Mode] to "1."	[RX Mode] "1"
	2	• Connect an SSG to the RX antenna connector.	• Set the SSG as; Level : +20 dBμ Modulation : 1 kHz Deviation : 3.5 kHz	– –
-Adjust- (Band center)	3	• CH. : 1-27 • Receiving	1) Set the SSG as; Frequency : 136.100 MHz 2) Select the item [BPF C ALL], then push the [ENTER] key.	[BPF C ALL] (Automatic adjustment)
(Band high)	4	• CH. : 1-28 • Receiving	• Set the preset adjustment value on the adjustment utility window. .	[BPFT1 H] "115"
				[BPFT2 H] "165"

6-4 RECEIVE ADJUSTMENT (continued)

1) Select an adjustment item using cursor or [↑] / [↓] keys of the PC's keyboard.

2) Set or modify the adjustment value as specified using [←] / [→] keys of the PC's keyboard, then push the [ENTER] key.

ADJUSTMENT	ADJUSTMENT CONDITION	OPERATION	ADJUSTMENT ITEM/POINT	VALUE	
S-METER -Preparation-	NOTE: "RECEIVE SENSITIVITY" MUST be adjusted before "S-METER." When "RECEIVE SENSITIVITY" is re-adjusted, "S-METER" MUST be re-adjusted too.				
	1	<ul style="list-style-type: none"> • Connect an SSG to the RX antenna connector. 	<ul style="list-style-type: none"> • Set the SSG as; Frequency : 173.900 MHz Modulation : 1 kHz Deviation : 3.5 kHz 	-	-
-Adjust- (S3 level)	2	<ul style="list-style-type: none"> • CH. : 1-29 • Receiving 	1) Set the SSG as; Level : +23 dB _μ 2) Select the item [RSSI S3 Level] , then push the [ENTER] key to store the adjust value.	[RSSI S3 Level]	(Automatic adjustment)
(S1 level)	3	<ul style="list-style-type: none"> • CH. : 1-29 • Receiving 	1) Set the SSG as; Level : -7 dB _μ 2) Select the item [RSSI S1 Level] , then push the [ENTER] key, to store the adjust value.	[RSSI S1 Level]	(Automatic adjustment)
SQUELCH	1	<ul style="list-style-type: none"> • CH. : 1-30 	<ul style="list-style-type: none"> • Set the item [SQL Level] to "2." 	[SQL Level]	"2"
	2	<ul style="list-style-type: none"> • Receiving 	<ul style="list-style-type: none"> • Set the preset adjustment value on the adjustment utility window. 	[SQL]	"35"

[FRONT UNIT]

REF NO.	ORDER NO.	DESCRIPTION	M.	H/V LOCATION
S506	2250000511	ECR RH70N1037E20-13F-2781		
SP501	2510001221	SP C052SB500-14		
W501	8900011800	CBL OPC-1199		
W502	8900017540	CBL OPC-1785		
EP501	8930065150	LCT SRCN-2781-SP-N-W (SHJ)		
EP503	6910019600	SCR LM-5		
EP504	6910019610	SCR LM-7 (SPACER)		

[MAIN UNIT]

REF NO.	ORDER NO.	DESCRIPTION	M.	H/V LOCATION
IC1	1110005330	S.IC NJM12904V-TE1-#ZZZB	T	58.1/71.4
IC2	1110007290	S.IC AK2330P-L	B	58.7/56.1
IC3	1130010100	S.IC LMX2352TMX/NOPB	B	120.2/43.9
IC4	1130010100	S.IC LMX2352TMX/NOPB	B	28/78.8
IC5	1110003491	S.IC TA31136FNG (D,EL)	B	70.4/82.5
IC7	1110007280	S.IC NJM2716F-TE1-#ZZZB	B	56.8/46.4
IC8	1130012910	S.IC AK4554VTP-E2/P	B	36.2/59.9
IC9	1190002080	S.IC AD7476ARTZ-500RL7	B	49.6/46.4
IC10	1130013040	S.IC TC7WBD125AFK (T5L,F)	B	46.6/49.2
IC11	1110006230	S.IC NJM2711F-TE1-#ZZZB	B	53.1/35
IC12	1140013290	S.IC TMS320VC5509AZHH	B	33.3/37.8
IC13	1180002590	S.REG XC6204B332MR	T	80.9/21.3
IC14	1180003270	S.REG R1114Q161D-TR-F	T	84.4/21.4
IC15	1180002590	S.REG XC6204B332MR	T	87.8/21.3
IC17	1190001340	S.IC M62334FP 600C	T	67.3/61.7
IC18	1110005771	S.IC S-80942CNMC-G9CT2G	T	41.2/52.8
IC19	1180003210	S.REG NJM2831F10	B	111/26.2
IC20	1140014550	S.IC HD64F2506RFC26DV	T	33.5/37.6
IC21	1140012950	S.IC 24LC512T-I/SM	T	59.1/21.8
IC22	1150002042	IC RA30H1317M-121 [EUR-01]		
	1150002073	IC RA60H1317M-125 [USA-01], [EXP-01]		
IC23	1110002751	S.IC TA75S01F (TE85R,F)	T	141.7/125.1
IC25	1130008561	S.IC TC75S51F (TE85L,F)	B	29/16.3
IC26	1120003070	S.IC MAX3232EIPWR	T	42.7/70
IC27	1180001251	S.IC TA7808F (TE16L,Q)	T	114.4/85
IC28	1110003091	IC LA4425A-E		
IC29	1110002751	S.IC TA75S01F (TE85R,F)	T	12/123.1
IC30	1110003390	S.IC AN8005M-(E1)	T	98.3/91.4
IC31	1130011760	S.IC CD4094BPWR	T	8.1/45.2
IC32	1130013360	S.IC AT25F2048N-10SU-2.7SL383	B	8.9/36.1
IC34	1110005340	S.IC NJM12902V-TE1-#ZZZB	B	12.2/58.2
IC35	1140013200	S.IC CD4053BPWR	B	20.6/58.2
IC36	1110005330	S.IC NJM12904V-TE1-#ZZZB	B	27.8/55.4
IC37	1120002830	S.IC NJM2125F-TE1-#FZZB	T	56.6/66.7
IC38	1110006380	S.IC LM2904PWR	T	114.1/23.8
IC39	1180001071	S.IC TA7805F (TE16L,Q)	T	101.2/24.3
IC40	1110005330	S.IC NJM12904V-TE1-#ZZZB	B	50.6/57.2
IC41	1180001251	S.IC TA7808F (TE16L,Q)	B	132/16.7
Q1	1590003230	S.TR UNR9113J-(TX)	B	53.4/79.7
Q2	1530002851	S.TR 2SC4116-BL (TE85R,F)	B	34.9/77.7
Q3	1560001360	S.FET 2SK3019 TL	B	66.4/76.3
Q5	1560000541	S.FET 2SK880-Y (T5RICOM,F)	B	35.7/107.1
Q7	1530002601	S.TR 2SC4215-O (TE85R,F)	B	73/92.9
Q8	1560000541	S.FET 2SK880-Y (T5RICOM,F)	B	89.5/46
Q9	1560001360	S.FET 2SK3019 TL	B	39.6/103.6
Q10	1530002851	S.TR 2SC4116-BL (TE85R,F)	B	89.5/43.5
Q11	1530002851	S.TR 2SC4116-BL (TE85R,F)	B	30.6/104.2
Q12	1590003230	S.TR UNR9113J-(TX)	B	66.1/100.3
Q13	1530002851	S.TR 2SC4116-BL (TE85R,F)	B	84.7/43.5
Q14	1530002851	S.TR 2SC4116-BL (TE85R,F)	B	30.6/107.1
Q15	1530002851	S.TR 2SC4116-BL (TE85R,F)	B	96.9/44.4
Q16	1530002851	S.TR 2SC4116-BL (TE85R,F)	T	35.2/108.3
Q19	1530002601	S.TR 2SC4215-O (TE85R,F)	B	63.2/106.8
Q20	1530002920	S.TR 2SC4226-T1 R25	B	39.9/123.1
Q21	1530002920	S.TR 2SC4226-T1 R25	B	39.6/114.5
Q22	1530002920	S.TR 2SC4226-T1 R25	B	95.2/64.3
Q23	1530002920	S.TR 2SC4226-T1 R25	B	95.2/54.5
Q24	1530003311	S.TR 2SC5107-O (TE85R,F)	B	100.6/58.6
Q25	1530003311	S.TR 2SC5107-O (TE85R,F)	B	44.9/117.4
Q26	1590001400	S.TR XP1214 (TX)	B	40.5/117.8
Q27	1590001400	S.TR XP1214 (TX)	B	96/59.6
Q28	1590003290	S.TR UNR9213J-(TX)	B	93.3/59.6
Q29	1590003290	S.TR UNR9213J-(TX)	T	57.2/41.9
Q30	1590003290	S.TR UNR9213J-(TX)	B	37.8/117.8
Q31	1590003230	S.TR UNR9113J-(TX)	T	57.2/39.8
Q32	1530003311	S.TR 2SC5107-O (TE85R,F)	B	46.2/111.7
Q33	1530003311	S.TR 2SC5107-O (TE85R,F)	B	101.9/53
Q34	1530003311	S.TR 2SC5107-O (TE85R,F)	B	46.2/123.1
Q35	1530003311	S.TR 2SC5107-O (TE85R,F)	B	101.9/64.4
Q36	1580000731	S.FET 3SK293 (TE85L,F)	B	48.3/136.6
Q37	1530003311	S.TR 2SC5107-O (TE85R,F)	B	132.4/84.5
Q38	1530002680	S.TR 2SC3357-T1	B	139.5/86
Q39	1560000841	S.FET 2SK1829 (TE85R,F)	B	54.2/142.5
Q40	1590001190	S.TR XP6501-(TX) .AB	T	101.6/87.4
Q41	1520000460	S.TR 2SB1132 T100 R	T	101.6/82.8
Q42	1590003290	S.TR UNR9213J-(TX)	T	13.3/67.6
Q43	1590003290	S.TR UNR9213J-(TX)	T	137.3/125
Q44	1590003290	S.TR UNR9213J-(TX)	T	114.3/80.1
Q45	1540000550	S.TR 2SD1664 T100Q	T	118.4/75.2
Q46	1530002851	S.TR 2SC4116-BL (TE85R,F)	T	137.3/120.2
Q48	1510000920	S.TR 2SA1577 T106 Q	T	101.5/77.8
Q49	1590003290	S.TR UNR9213J-(TX)	T	102.2/73.7
Q52	1590003290	S.TR UNR9213J-(TX)	T	10.9/131.6
Q53	1590003290	S.TR UNR9213J-(TX)	T	10.9/129.6
Q56	1590003321	S.FET TPC6103 (TE85L,F)	T	7.6/132.6
Q57	1550000100	S.FET 2SJ377 (TE16L1,NQ)	T	123.3/99.6
Q58	1590003290	S.TR UNR9213J-(TX)	T	129.4/102.2
Q59	1590000990	S.TR DTC363EK T146	T	7.6/127.6
Q61	1530002851	S.TR 2SC4116-BL (TE85R,F)	T	6.8/118.4
Q62	1540000441	S.TR 2SD1619T-TD-E	T	118.4/18.6
Q63	1560000990	S.FET PMBFJ310	B	66.3/110
Q64	1560000990	S.FET PMBFJ310	B	63.4/110
Q65	1530003311	S.TR 2SC5107-O (TE85R,F)	B	59.6/123.7
Q66	1590003290	S.TR UNR9213J-(TX)	B	94.9/4.7
Q67	1590003290	S.TR UNR9213J-(TX)	B	124.9/4.7
Q68	1590003290	S.TR UNR9213J-(TX)	B	109.9/4.7
Q69	1590003290	S.TR UNR9213J-(TX)	T	9.5/53.3
Q70	1590003230	S.TR UNR9113J-(TX)	T	9.5/51
Q71	1560000990	S.FET PMBFJ310	B	60.5/110
Q72	1530002851	S.TR 2SC4116-BL (TE85R,F)	B	107/26.3

M.=Mounted side (T: Mounted on the Top side, B: Mounted on the Bottom side)
S.=Surface mount

[MAIN UNIT]

Table with columns: REF NO., ORDER NO., DESCRIPTION, M., H/V LOCATION. Contains items R291 through R468, including various ERJ2GEJ and MCR10EZHJ components.

[MAIN UNIT]

Table with columns: REF NO., ORDER NO., DESCRIPTION, M., H/V LOCATION. Contains items R469 through R548, including ECJ0EC and ECJ0EB components.

M.=Mounted side (T: Mounted on the Top side, B: Mounted on the Bottom side) S.=Surface mount

VOLTAGE DIAGRAM

FRONT UNIT

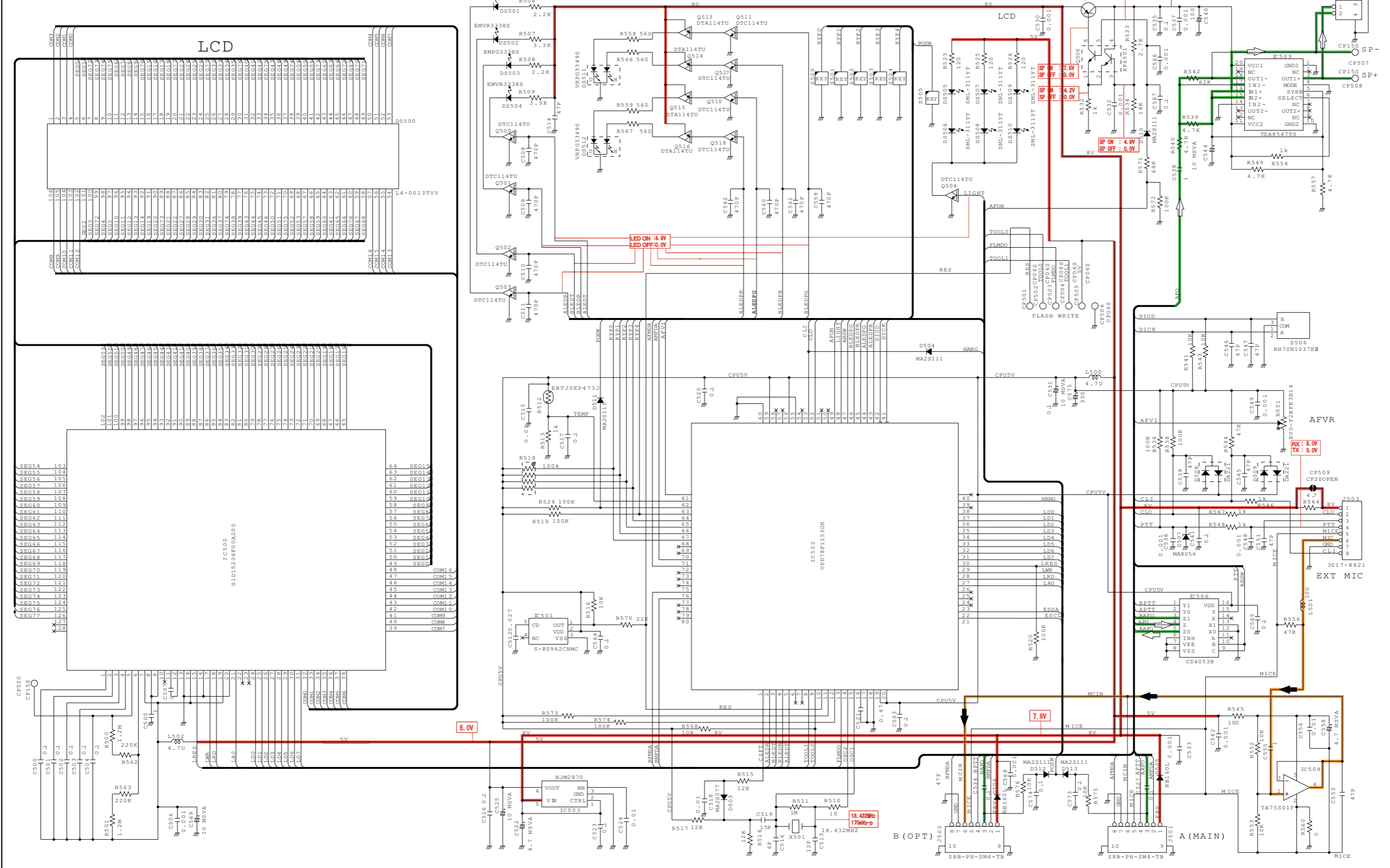

*; Refer to "PARTS LIST"

MAIN UNIT (1/3)

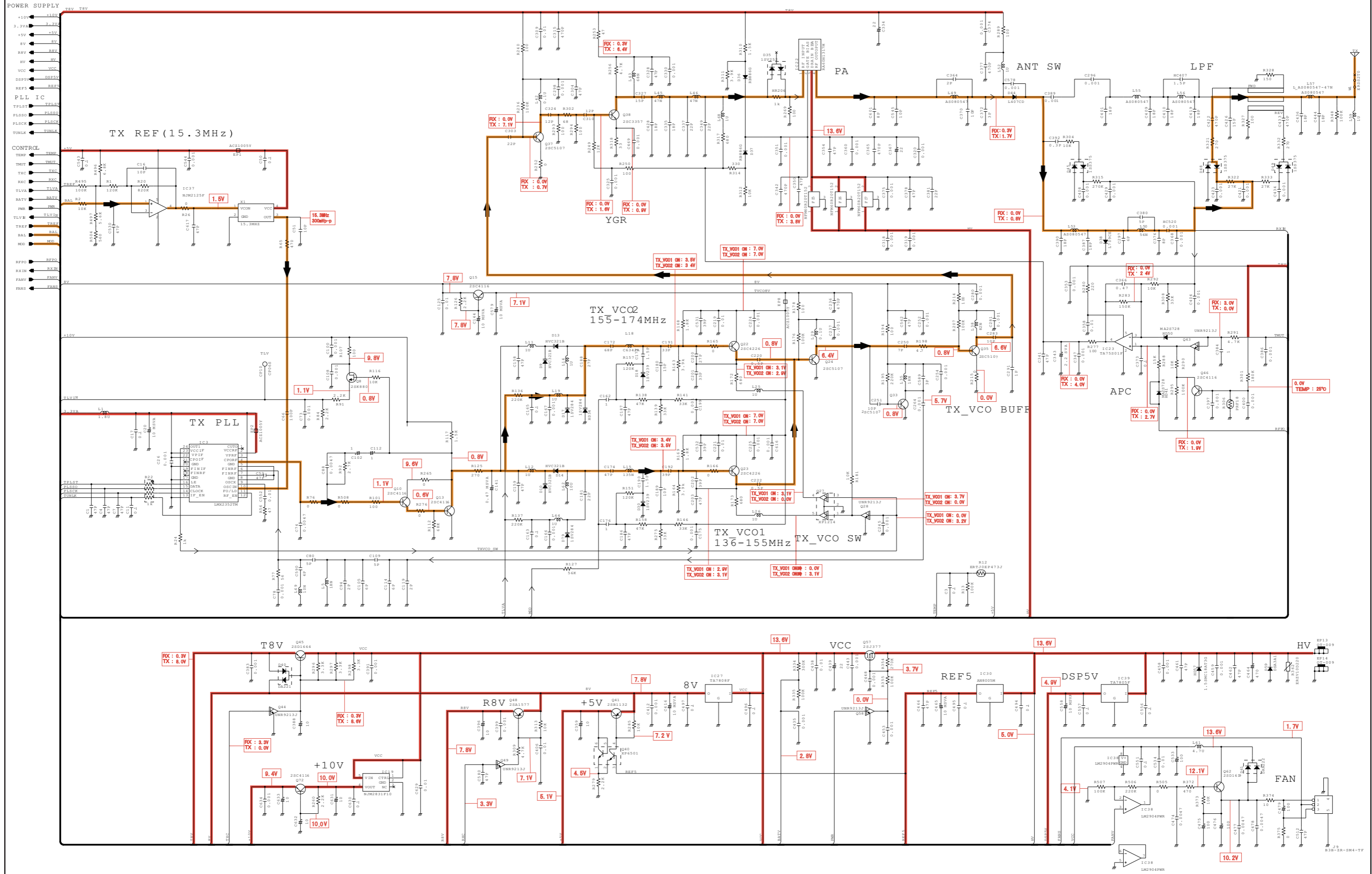

*; Refer to "PARTS LIST"

MAIN UNIT (2/3)

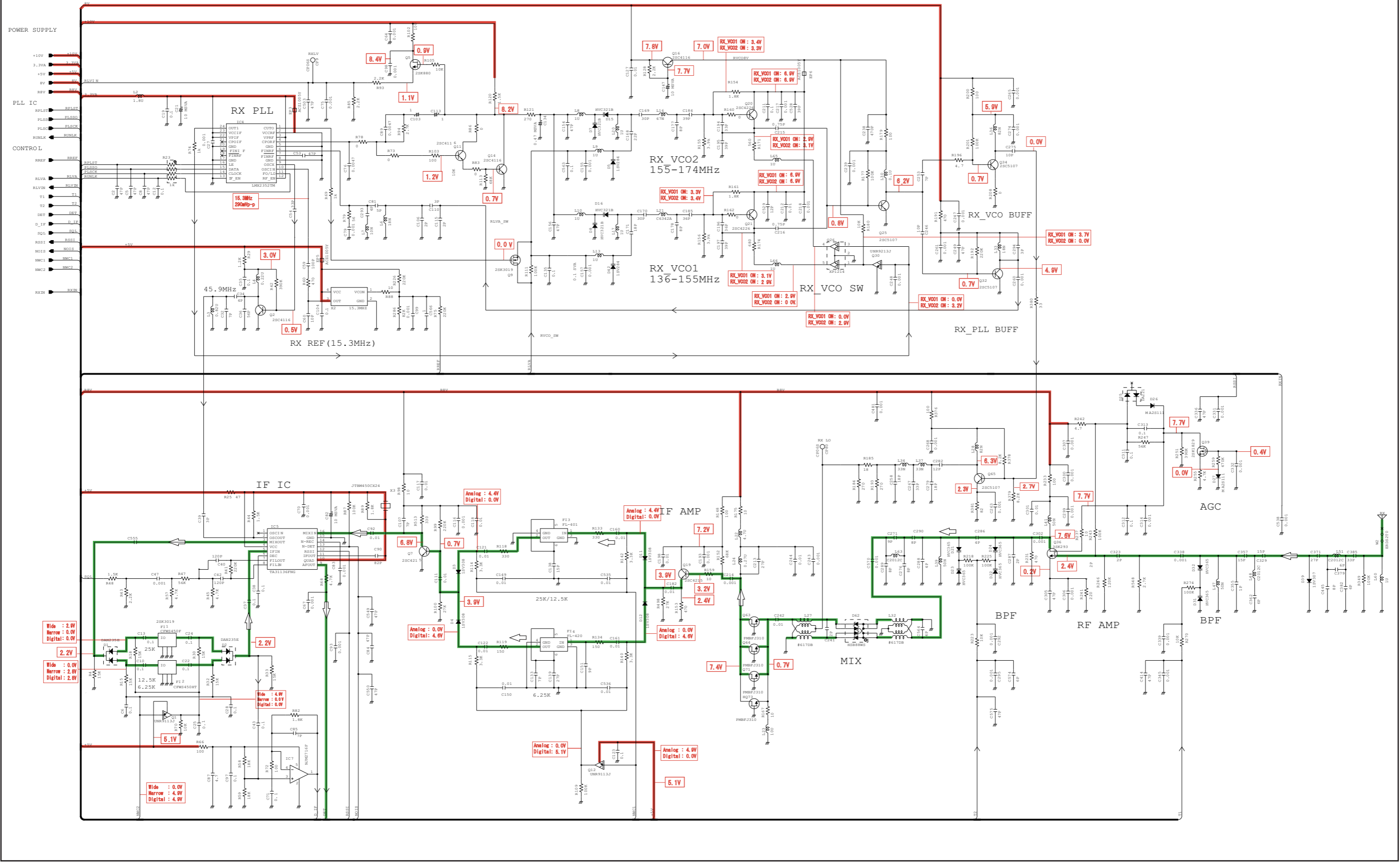

*; Refer to "PARTS LIST"

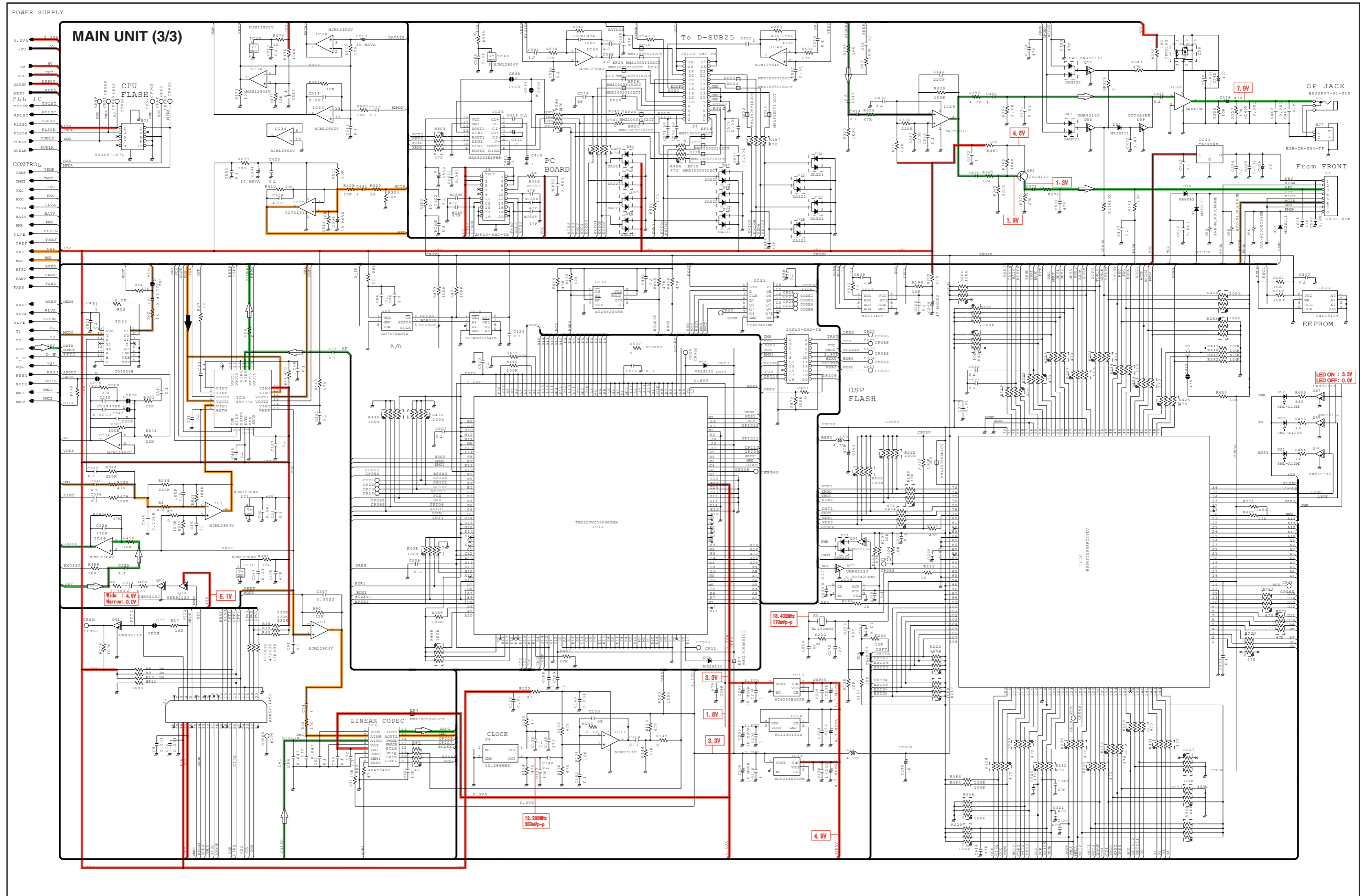

*; Refer to "PARTS LIST"

• ACCESSORY CONNECTOR (CONNECT UNIT) INFORMATION

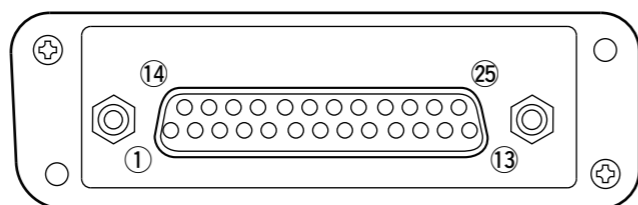
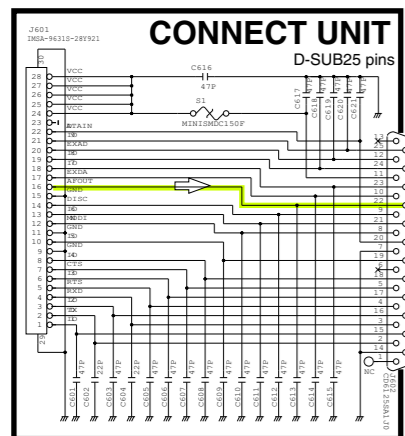

Pin No.	Pin Name	Description	Specification
1	NC	No connection	—
2	TXD	Output terminal for serial communication data.	—
3	RXD	Input terminal for serial communication data.	—
4	RTS	Output terminal for request-to-send data.	—
5	CTS	Input terminal for clear-to-send data.	—
6	NC	No connection	—
7	GND	Serial/digital signal ground	—
8	MOD IN	Modulator input from an external terminal unit.	Input level: 300 mV rms
9	DISC OUT	Output terminal for AF signals from the AF detector circuit. Output level is fixed, regardless of [AF] control.	Output level: 300 mV rms
10	EXT. D/A	The desired function can be assigned.* (Default: Null)	—
11	VCC	13.6 V (FR6000)/13.2 V (FR6100) DC output	Output current: Less than 1 A
12	EXT. A/D	Customize A/D input (Not used)	—
13	NC	No connection	—
14	GND	Ground	—
15	EXT./O 15	The desired function can be assigned.* (Default: Null)	+5 V pull up, Active=L
16	EXT./O 16	The desired function can be assigned.* (Default: P0 Monitor Output)	+5 V pull up, Active=L
17	EXT./O 17	The desired function can be assigned.* (Default: Busy Output)	+5 V pull up, Active=L
18	EXT./O 18	The desired function can be assigned.* (Default: Null)	+5 V pull up, Active=L
19	EXT./O 19	The desired function can be assigned.* (Default: EPTT Input)	+5 V pull up, Active=L
20	DATA IN	Input terminal for data.	—
21	EXT./O 21	The desired function can be assigned.* (Default: Analog Audible Output)	+5 V pull up, Active=L
22	AF OUT	The AF detector Output.	—
23	EXT./O 23	The desired function can be assigned.* (Default: Mic Mute Output)	+5 V pull up, Active=L
24	EXT./O 24	The desired function can be assigned.* (Default: Null)	+5 V pull up, Active=L
25	EXT./O 25	The desired function can be assigned.* (Default: Mic Hanger Output)	+5 V pull up, Active=L

* The desired function can be assigned using the optional CS-FR5000 CLONING SOFTWARE. Ask your dealer for details.



SERVICE MANUAL

VHF FM REPEATER

IC-FR5000
IC-FR5100

S-14425XZ-C1
Jun. 2008

Icom Inc.

INTRODUCTION

This service manual describes the latest service information for the **IC-FR5000 IC-FR5100** VHF FM REPEATER at the time of publication.

MODEL	VERSION	CH. SPACING (kHz)	TX POWER	FREQUENCY RANGE
IC-FR5000	USA-01	7.5/15/30	50 W	136-174 MHz
	EXP-01	12.5/25.0		
IC-FR5100	EUR-01	12.5/20.0/25.0	25 W	

UNIT ABBREVIATIONS:

F=FRONT UNIT
M=MAIN UNIT
CN=CONNECT UNIT

CAUTION

NEVER connect the repeater to an AC outlet or to a DC power supply that uses more than specified. This will ruin the repeater.

DO NOT expose the repeater to rain, snow or any liquids.

DO NOT reverse the polarities of the power supply when connecting the repeater.

DO NOT apply an RF signal of more than 20 dBm (100 mW) to the antenna connector. This could damage the repeater's front-end.

To upgrade quality, any electrical or mechanical parts and internal circuits are subject to change without notice or obligation.



ORDERING PARTS

Be sure to include the following four points when ordering replacement parts:

1. 10-digit Icom parts numbers
2. Component name
3. Equipment model name and unit name
4. Quantity required

<ORDER EXAMPLE>

1110003491 S.IC TA31136FNG IC-FR5000 MAIN UNIT 5 pieces
8820001210 Screw 2438 screw IC-FR5000 Top cover 10 pieces

Addresses are provided on the inside back cover for your convenience.

REPAIR NOTES

1. Make sure the problem is internal before disassembling the repeater.
2. **DO NOT** open the repeater until the repeater is disconnected from its power source.
3. **DO NOT** force any of the variable components. Turn them slowly and smoothly.
4. **DO NOT** short any circuits or electronic parts. An insulated tuning tool **MUST** be used for all adjustments.
5. **DO NOT** keep power ON for a long time when the repeater is defective.
6. **DO NOT** transmit power into a Standard Signal Generator or a Sweep Generator.
7. **ALWAYS** connect a 50 dB to 60 dB attenuator between the repeater and a Deviation Meter or Spectrum Analyzer when using such test equipment.
8. **READ** the instructions of test equipment thoroughly before connecting a test equipment to the repeater.

CONTENTS

SECTION 1 SPECIFICATIONS

SECTION 2 INSIDE VIEWS

SECTION 3 DISASSEMBLY INSTRUCTION

SECTION 4 OPTIONAL UNIT INSTALLATION

SECTION 5 CIRCUIT DESCRIPITON

5-1	RECEIVER CIRCUITS.....	5-1
5-2	TRANSMITTER CIRCUITS.....	5-1
5-3	OTHER CIRCUITS.....	5-2
5-4	CPU (M: IC20) PORT ALLOCATION.....	5-3

SECTION 6 ADJUSTMENT PROCEDURES

6-1	PREPARATION.....	6-1
6-2	FREQUENCY ADJUSTMENT.....	6-6
6-3	TRANSMIT ADJUSTMENT.....	6-7
6-4	RECEIVE ADJUSTMENT.....	6-8

SECTION 7 PARTS LIST

SECTION 8 MECHANICAL PARTS

SECTION 9 BOARD LAYOUTS

SECTION 10 BLOCK DIAGRAM

SECTION 11 VOLTAGE DIAGRAM

FRONT UNIT.....	11-1
MAIN UNIT (1/3).....	11-2
MAIN UNIT (2/3).....	11-3
MAIN UNIT (3/3).....	11-4
CONNECT UNIT.....	11-5

SECTION 1

SPECIFICATIONS

■ GENERAL		[FR5000]	[FR5100]
• Frequency coverage		136–174 MHz	
• Conventional channels		max. 32 ch	
• Type of emission	Wide	16K0F3E	
	Middle	–	14K0F3E
	Narrow	11K0F3E/11K0F7E/11K0F7D/11K0F7W/ 8K50F3E ([EXP-01] only)	8K50F3E
	Digital	4K00F1E/4K00F1D/4K00F3E	
• Antenna impedance		50 Ω (Nominal)	
• Operating temperature range		–22°F to +140°F (–30°C to +60°C)	–25°C to +55°C
• Power supply requirement (nominal)		13.6 V DC (Negative ground)	13.2 V DC (Negative ground)
• Current drain (Approx.)	Receiving	500 mA (stand-by), 1900 mA (max. audio)	
	Transmitting	15 A (at 50 W)	8.0 A (at 25 W)
• Dimensions (Projections not included)		19 (W)×3 15/32 (H)×10 1/4 (D) in.	483 (W)×88 (H)×260 (D) mm
• Weight (Approx.)		12 lb 5 17/32 oz.	5.6 kg

■ TRANSMITTER		[FR5000]	[FR5100]
• Output power		50 W	25 W
• Modulation		Variable reactance frequency modulation	
• Max. frequency deviation	Wide	±5.0 kHz	
	Middle	–	±4.0 kHz
	Narrow	±2.5 kHz	
• Frequency stability		±0.5 ppm	±0.2 kHz
• Spurious emissions		80 dB typ.	0.25 μW (≤1 GHz), 1.00 μW (>1 GHz)
• Adjacent channel power	Wide	76 dB typ.	76 dB typ.
	Middle	–	76 dB typ.
	Narrow	69 dB typ.	70 dB typ.
	Digital	65 dB typ.	66 dB typ.
• Audio harmonic distortion		1% typ. (at AF 1 kHz 40% deviation)	
• Intermodulation attenuation		–	40 dB min.
• Audio frequency response		+2 dB to –8 dB of 6 dB/oct. Wide/Middle from 300 Hz to 3000 Hz Narrow from 300 Hz to 2550 Hz	
• FM Hum and noise (300 Hz–3000 Hz, 750 μs)	Wide	52 dB typ.	–
	Narrow	49 dB typ.	
• Audio input impedance (Microphone)		600 Ω	

■ RECEIVER		[FR5000]	[FR5100]
• Receive system		Double-conversion superheterodyne system	
• Intermediate frequencies		1st IF: 46.35 MHz, 2nd IF: 450 kHz	
• Sensitivity	Wide/Narrow	0.3 μ V typ. at 12 dB SINAD	-10 dB μ V max. at 12 dB SINAD
	Wide/Middle/Narrow	–	-10 dB μ V max. at 12 dB SINAD
	Digital	0.25 μ V typ. at 5% BER	0 dB μ V emf max. at 1% BER (PN9)
• Squelch sensitivity (at threshold)		0.25 μ V typ.	
• Adjacent channel selectivity	Wide	80 dB typ. (TIA-603-B) 85 dB typ. (TIA-603)	86 dB typ.
	Middle	–	83 dB typ.
	Narrow	56 dB typ. (TIA-603-B) 77 dB typ. (TIA-603)	77 dB typ.
	Digital	66 dB typ. (EN 301 166, 400 Hz @1%) 63 dB typ. (EN 301 166, PN15 @5%)	67 dB typ.
• Spurious response	Analog	90 dB	80 dB typ.
	Digital	90 dB μ V emf	90 dB μ V emf typ.
• Intermodulation	Wide	78 dB typ.	72 dB typ.
	Middle	–	72 dB typ.
	Narrow	78 dB typ.	71 dB typ.
	Digital	75 dB μ V emf typ.	76 dB μ V emf typ.
• Hum and noise	Wide	52 dB typ.	–
	Middle	–	–
	Narrow	50 dB typ.	–
	Digital	66 dB typ.	–
• Audio output power (at 5% distortion with a 4 Ω load)		4.0 W typ.	3.5 W min.
• Audio output impedance		4 Ω	

Specifications are measured in accordance with TIA-603-B (for Wide and Narrow) or EN 300 166 (Digital) for FR5000.

Specifications are measured in accordance with EN 300 086 (for Wide, Middle and Narrow) or EN 301 166 (Digital) for FR5100.

All stated specifications are subject to change without notice or obligation.

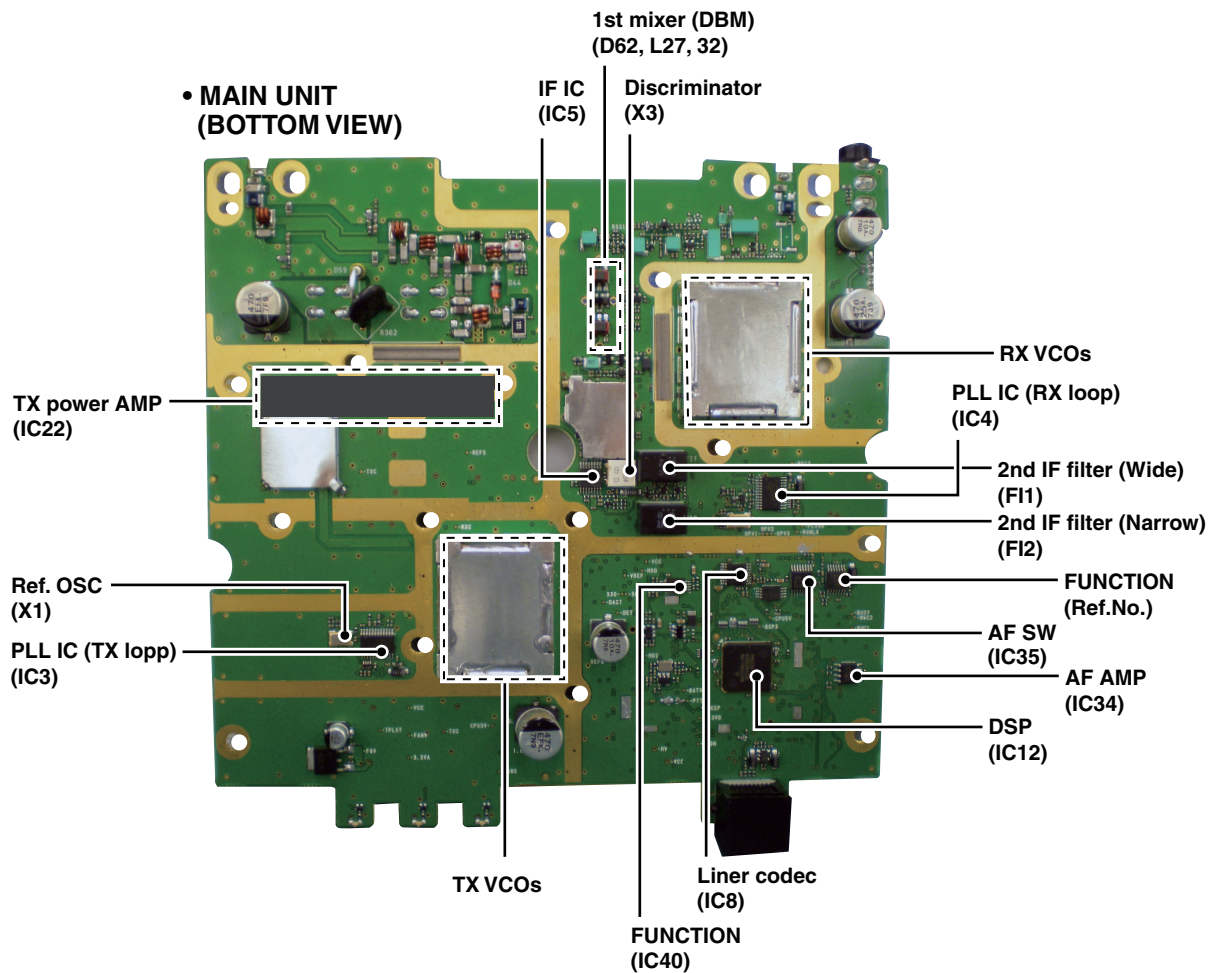
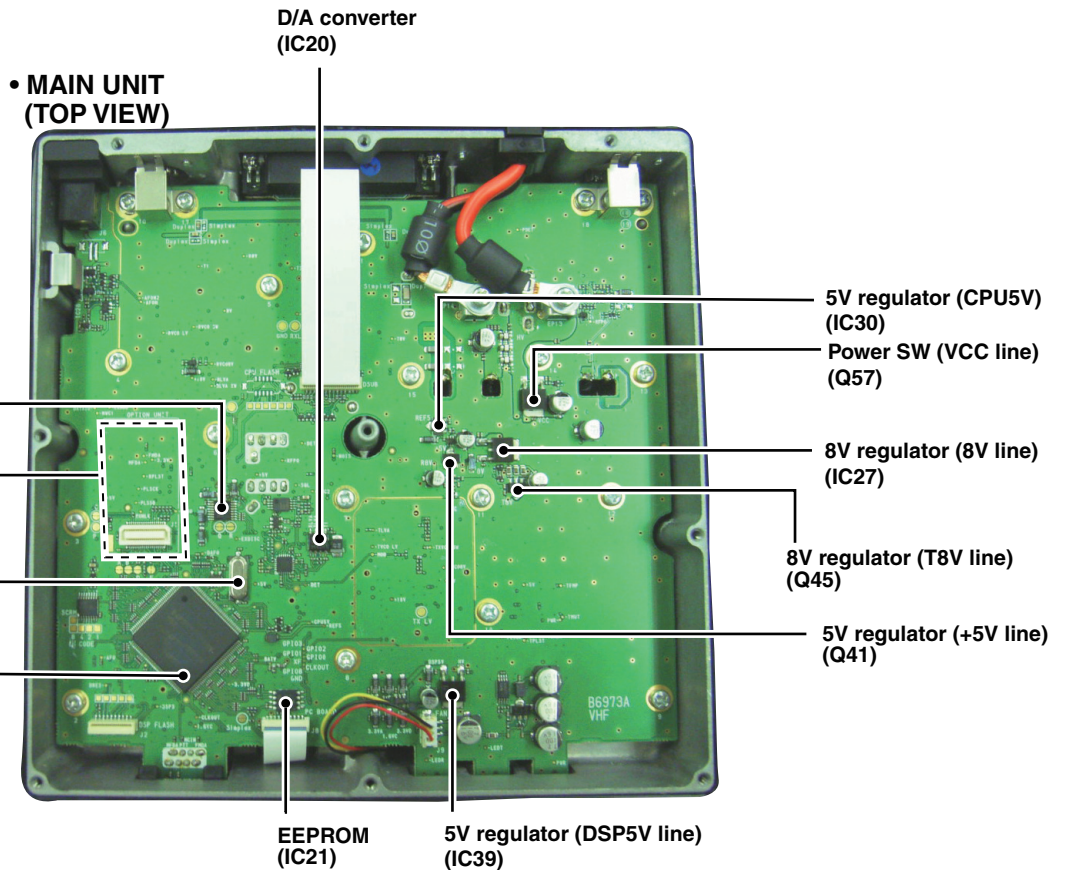

• FRONT UNIT

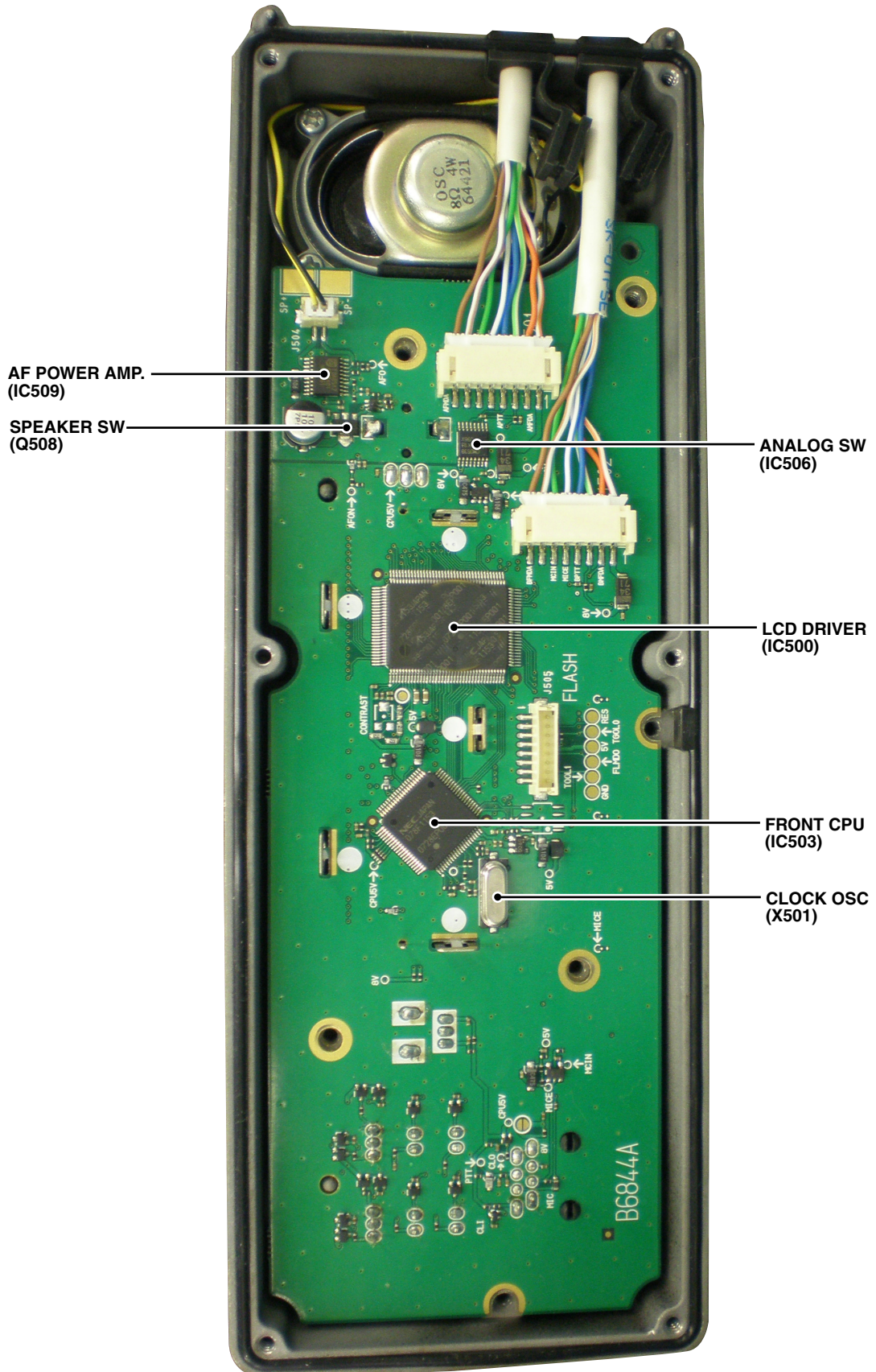

SECTION 3 DISASSEMBLY INSTRUCTION

1. Removing the front panel

① Unscrew 11 screws from the top cover.

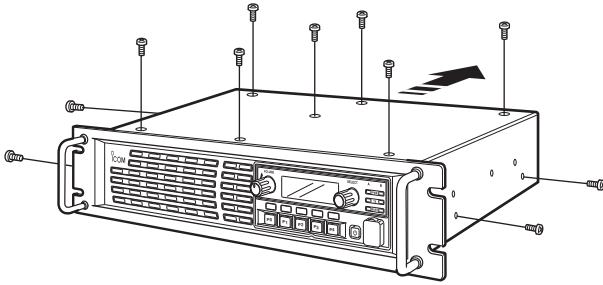

② Unscrew 7 screws from the front panel.

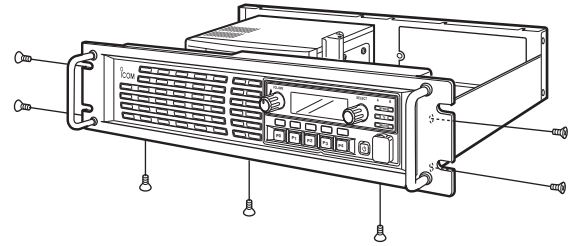

③ Disconnect the cable from the MAIN UNIT assembly, and remove the front panel.

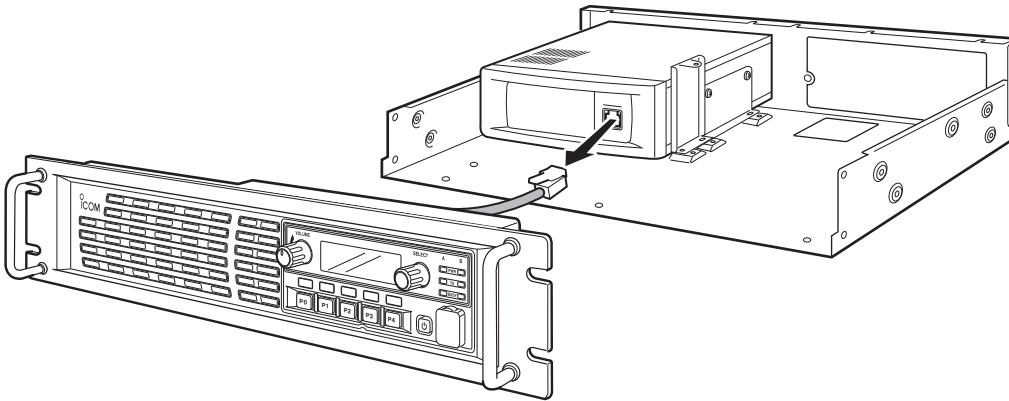

2. Removing the MAIN UNIT assembly

① Unscrew 5 screws which settles the MAIN UNIT assembly.

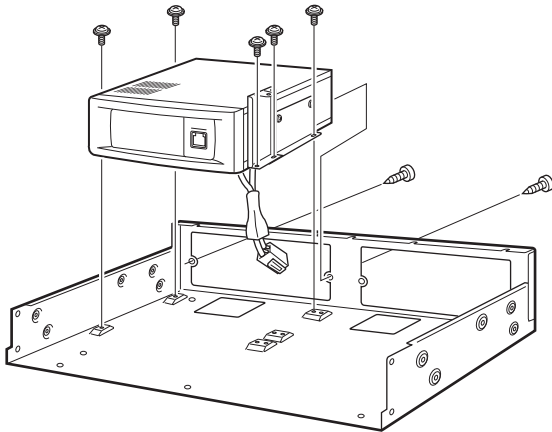

② Turn the MAIN UNIT assembly upside down.

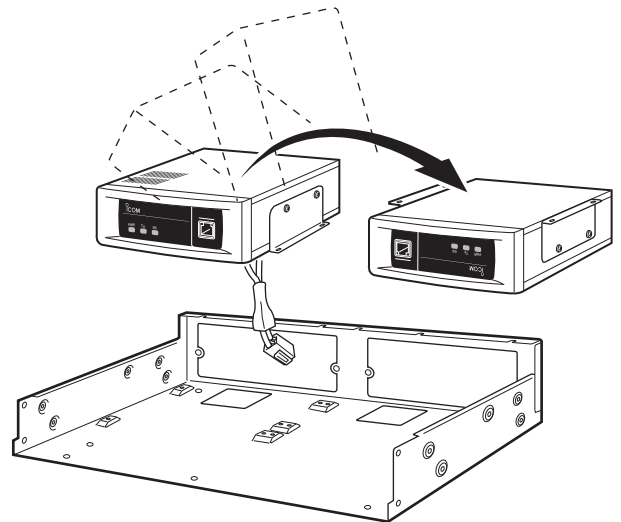

3. Removing the MAIN UNIT

① Unscrew 9 screws, and remove the cover.

(If you are going to install an optional unit, see page 4-1 for the installation.)

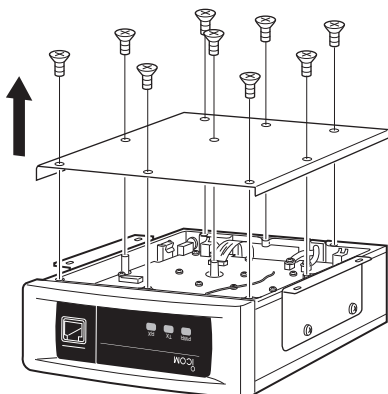

(To be continued to next page)

- ② Unsolder 2 points at the ANT cases.
- ③ Unscrew 4 screws from the ANT cases, and remove them.
- ④ Disconnect the flat cable from J4 and the speaker cable from J9.

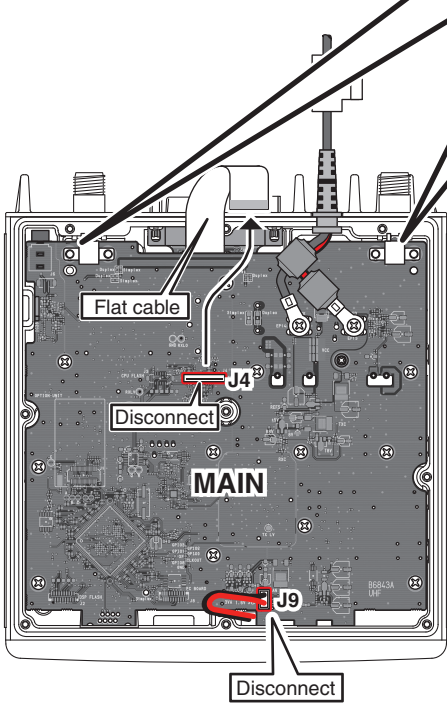
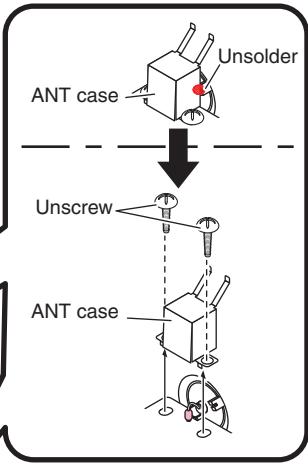

- ⑤ Unsolder 2 points at the bottom of ANT connectors.
- ⑥ Unsolder 4 points at the PA module leads.
- ⑦ Unscrew 2 screws from W4.

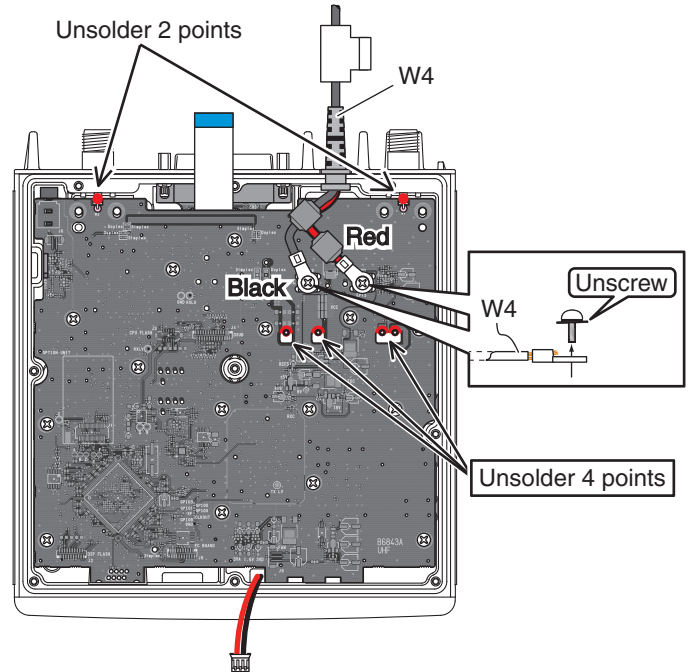

- ⑧ Remove the clip from the side of chassis.
- ⑨ Unscrew 15 screws from the MAIN UNIT, then take off the MAIN UNIT PCB from the chassis.

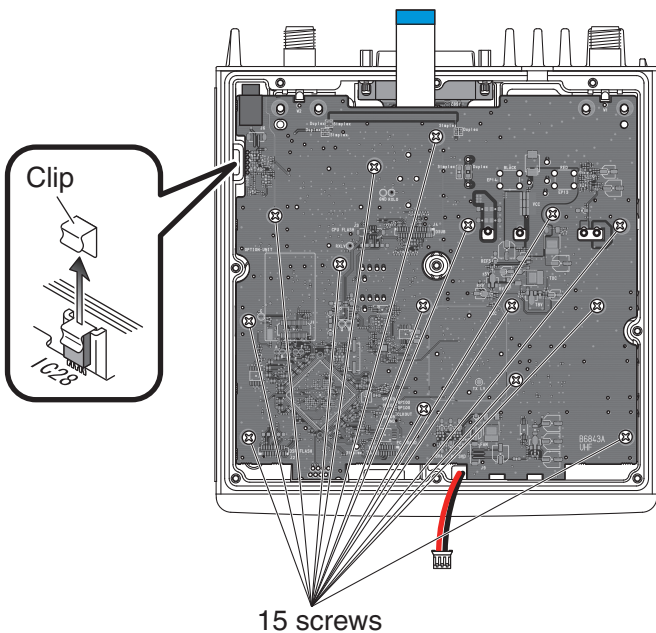

SECTION 4 OPTIONAL UNIT INSTALLATION

Install UT-109R or UT-110R as follows.

- ① Disassembly the repeater until the MAIN UNIT is exposed. (See the page 3-1)
- ② Modify the patterns on the MAIN UNIT as below.

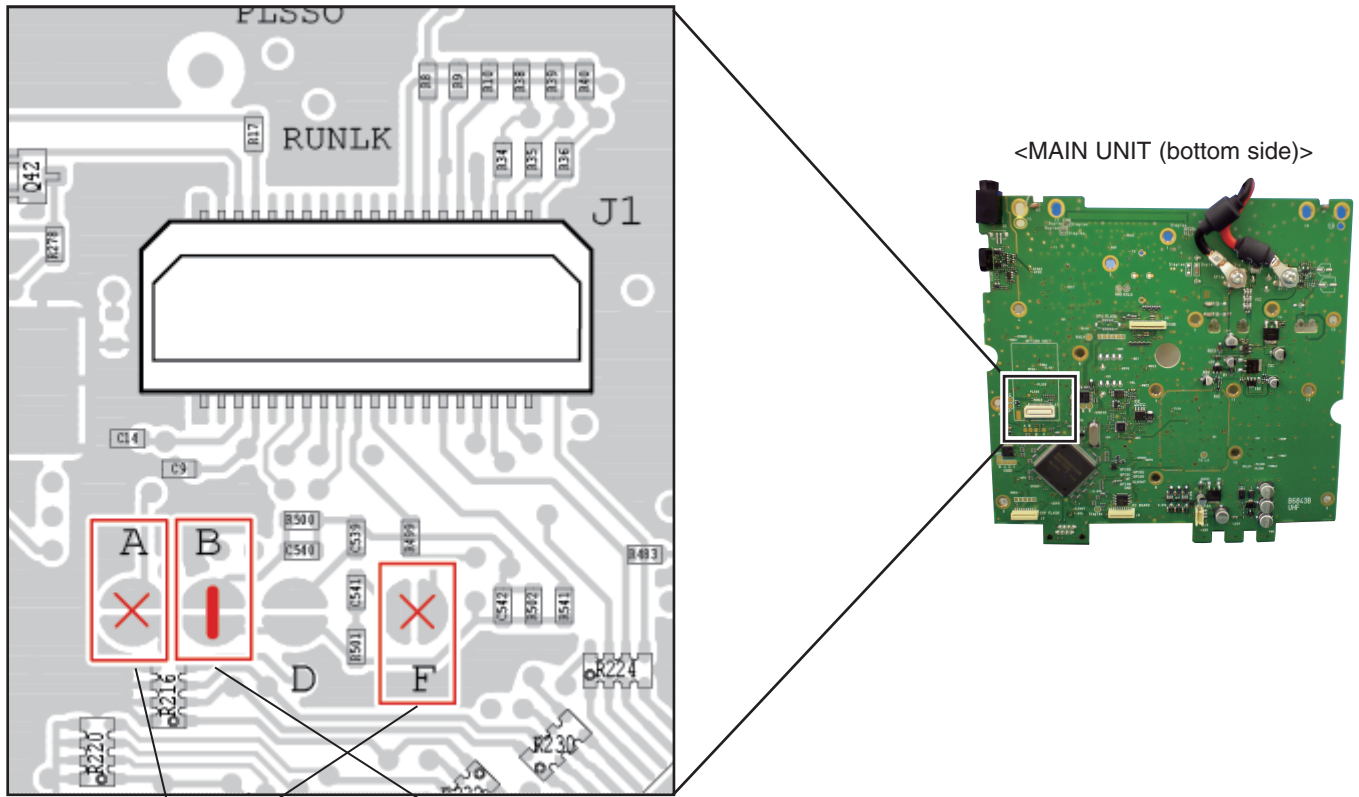

A and F; Cut the pattern

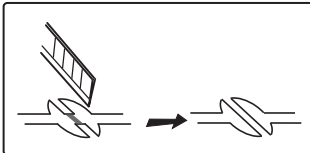

B; Short the pattern

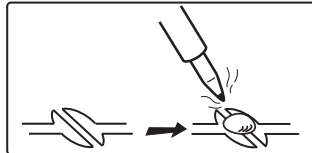

- ③ Remove the protective paper of optional unit, and install it to the J1 as below.

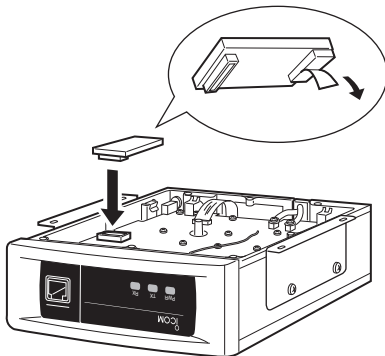

- ④ Replace the cover, screws, etc. to recover the whole assembly.

NOTE: When uninstalling the scrambler unit

Be sure to recover the disconnected or connected points, otherwise no TX modulation or AF output is available.

5-1 RECEIVER CIRCUITS

RF BPF CIRCUITS

RX signals from the RX antenna connector (J11) are passed through the 1st stage of BPF (D28, 29, 31, 32, L44, 47) then amplified by the RF AMP (Q36). The amplified RX signals are passed through the 2nd stage of BPF (D28, 29, 31, 32, L44, 47) to remove unwanted signals for good image response then applied to the 1st mixer (L27, 32, D62).

Being mixed with 1st LO signals from the RX VCO, the RX signals are converted into the 46.35 MHz 1st IF signal.

The 1st and 2nd stage of the BPFs are tuned to the pass band frequency by tracking voltage "T1" and "T2" from the DAC (IC17). The gain of low noise RF AMP (Q36) is controlled by the AGC circuit (Q39, D27) according to the RX signal strength.

IF FILTER/IF AMP CIRCUITS

The 1st IF signal from the 1st mixer (L27, 32, D62) is amplified by the buffer AMP (Q63, 64, 71) and 1st stage of IF AMP (Q19) then filtered by crystal filter (FI3 or FI4), and then applied to the IF IC (IC5).

The crystal filters (FI3 or FI4) are switched by the "NWC1" signal from the CPU (IC20) according to the RX mode; Wide (Middle), Narrow or Digital.

<ANALOG RX>

Being mixed with the 2nd LO, the 1st IF signal is converted into the 450 kHz 2nd IF signal. The 2nd IF signal is passed through the external ceramic filter (FI1 or FI2), then FM-demodulated by the internal quadrature detector with discriminator (X3). The demodulated AF signals are amplified by the AF AMP (IC36), and applied to the LINER CODEC (IC8). The AF signals are converted into the digital audio signal then processed by the DSP (IC12) then recovered to the analog audio signals.

The ceramic filter (FI1 or FI2) is switched by the "NWC2" signal from the CPU (IC20) according to the RX mode; Wide (Middle), Narrow or Digital.

<DIGITAL RX>

The 450 kHz 2nd IF signal is amplified by IC7 then applied to the DSP (IC12) via ADC (IC9), and digital-demodulated. The processed digital signal is converted into the analog audio signal by the LINEAR CODEC (IC8).

AF AMPLIFIER CIRCUITS

The AF signals from the LINEAR CODEC are amplified by the AF AMP (IC36) and level-adjusted by DAC (IC2), then applied to IC28 via IC29 to be power-amplified.

SIGNALING (DECODE)

The Continuous Tone (CTCSS/DTCS), Single Tone (5-Tone/DTMF/CW_ID) signals in the demodulated AF signals are decoded in the DSP (IC8).

5-2 TRANSMITTER CIRCUITS

MODULATION CIRCUITS

The demodulated signals are applied to the MIC AMP (IC25). The amplified Demodulated signals are passed through the SW IC (IC35) which selects the source of Demodulated signals from J5 (from MIC) and from D-SUB connector (DEXM).

The Demodulated signals from the SW IC are amplified by an AMP (IC1) then applied to the LINEAR CODEC IC (IC8) where the Demodulated signals are converted in to the digital audio signals.

The converted digital audio signals are processed (pre-emphasis, limit, etc.) by the DSP (IC12), then recovered to the analog audio signals by LINER CODEC IC (IC8). The AF signals are amplified by IC1 and level-adjusted by Electronic VR (IC2), then applied to the TX VCO and TCXO (X1) as the modulation signals.

SIGNALING (ENCODE)

The Continuous Tone (CTCSS/DTCS), Single Tone (5-Tone/DTMF/CW_ID) signals are encoded, and mixed with Demodulated signals in the DSP (IC12).

YGR/PA CIRCUITS

The output signals from TX VCOs are amplified to the level required for the PA module by pre-AMPs (Q37, 38), then amplified by the PA module (IC22) to obtain TX output power. The power-amplified TX signal is passed through the ANT SW (D44) and LPF (for harmonics removal) then applied to the TX antenna.

APC CIRCUIT

D45, D48 and D49 detect the TX power, and the detected voltage is applied to the IC23 in APC circuit. Comparing the detected voltage which is in proportion to the TX power and power setting voltage as the reference voltage, IC23 adjusts the bias voltage of PA module (pin 2: VGG terminal) and pre-AMP (Q38) to control the TX power.

5-3 FREQUENCY SYNTHESIZER CIRCUITS

RX PLL CIRCUIT

The RX PLL IC (IC4) outputs resulting signal; phase-comparison of reference signal (15.3 MHz) from the TCXO (X2) and feedback OSC signal from the RX VCO. The phase-difference signal is passed through the active loop filter (Q11, 14) and applied to the RX VCO as the lock voltage. The voltage of RX LV (lock voltage) is adjusted to appropriate one by "RX LVA" signal.

A portion of reference frequency signal (15.3 MHz) from the TCXO (X2) is passed through the tripler (Q2) to extract 3rd harmonic, then applied to the IF IC (IC5).

RX VCO

There are 2 VCOs; VCO for lower band (Q21, D8, 16, L17) and higher band (Q20, D7, 15, L20), and these VCOs (=OSC freq.) are switched by the VCO SW (Q26, 30). The OSC frequencies of these VCOs are adjusted (=Locked) to desired one by the RX LV signal (Lock Voltage). The output signals of these VCOs are applied to the 1st mixer (L27, 32, D62) via buffer (Q25).

A portion of output signal from the buffer (Q25) is applied to the doubler (Q32) to extract 2nd harmonic, then applied to the PLL IC (IC4) via the LPF.

TX PLL CIRCUIT

TX PLL IC (IC3) outputs resulting signal; phase-comparison of reference signal (15.3 MHz) from the TCXO (X1) and feedback OSC signal from the TX VCO. The phase-difference signal from the PLL IC (IC3) is passed through the active loop filter (Q10, 13) and applied to the TX VCO as the lock voltage. The lock voltage "TX LV" is adjusted to appropriate one by the LVA signal. The OSC signal of TCXO (X1) is FM-modulated by applied modulation signals.

TX VCO CIRCUITS

There are 2 VCOs; VCO for lower band (Q23, D10, 14, L62) and higher band (Q22, D9, 13, L14), and these VCOs (=OSC frequencies) are switched by the VCO SW (Q27, 28). The OSC frequencies of these VCO are adjusted (=Locked) to desired one by the TX LV signal (Lock Voltage).

The modulation signals applied to the Variable Capacitor (VD; D18 or D30) vary the capacitor reactance of it for FM modulation. The output signals of these VCOs are applied to the YGR/PA circuits via buffers (Q24, 35).

A portion of these output signal is passed through the doubler (Q33) to extract 2nd harmonic, then applied to the PLL IC (IC3) via the LPF.

5-4 OTHER CIRCUITS

POWER SUPPLY

The power supply is switched by Q57 (ON/OFF). 5V (REF5) from the regulator (IC30) is passed through L58 to supply to CPU. The 5V also supplies to other sections of the repeater via Q41 as "+5V."

8V from the regulator (IC27) are supplies to various circuits, and also supplies to TX circuits as "T8V" and RX circuits as "8V."

5V from the regulator (IC39) supplies DSP as "DSP5" and supplies logic circuits; CPU, DSP, etc. via regulators (IC13, 14, 15).

The regulator "F8V" (IC41) provides the supply for FRONT UNIT.

COMPANDER

The compander in the DSP (IC12) compresses the amplitude of Demodulated signals in TX, and expands in RX to provide high quality, high S/N ratio recovered sounds.

LEDs

DS1 (BUSY), DS2(PWR) and DS3 (TX) indicate the repeater's status: Power ON, T/RX and Cloning.

5-5 CPU (M: IC20) PORT ALLOCATION

Pin No.	LINE NAME	DESCRIPTION	IN/OUT	CONDITION
1–11	D5–D15	DSP data bus line.	I/O	–
15–28	A1–A14	DSP data bus line.	I/O	–
29	HRW	DSP data line.	I/O	–
32	FANS	Cooling fan (CH: MF1) rotation detect.	I	"H"=While the cooling fan is rotating.
33	TLED	TX indicator LED control signal.	O	"H"=TX
34	LEDR	RX indicator LED control signal.	O	"H"=Squelch open.
35	PLSCK	PLL (M: IC4) serial clock.	O	–
36	PLSSO	PLL (M:IC4) serial data.	O	–
41	PWON	Power line "VCC" control signal.	O	"H"=Power ON.
42	AFON2	AF power AMP. (M: IC28) control signal.	O	"H"=AF power AMP ON.
43	AFON	AF output select signal.	O	"H"=AF signals are output from the [ACCESSORY CONNECTOR].
44	ESCL	Serial clock to the EEPROM (M: IC21).	O	–
45	ESDA	Serial data to the EEPROM (M: IC21).	O	–
46	TXC	TX power line "T8V" control signal.	O	"H"=TX
47	RXC	RX power line "R8V" control signal.	O	"H"=RX
48	RPLST	RX PLL (M: IC4) strobe.	O	–
49	TPLST	TX PLL (M: IC3) strobe.	O	–
50	RUNLK	RX PLL (M: IC4) unlock signal.	I	"L"=Unlocked
51	TUNLK	TX PLL (M: IC3) unlock signal.	I	"L"=Unlocked
52	XCTS	Serial data from the RS-232 line driver (M: IC26).	I	–
53	XRTS	Serial data to the RS-232 line driver (M: IC26).	O	–
55	EXDA	External D/A port.	O	–
56	BEEP	Beep sounds (square waves).	O	–
57–59	OPV3–OPV1	Optional unit detect.	I	–
60	MMUT	MIC mute signal to the installed optional unit.	O	"H"=MIC mute
61	HANG	Microphone hang-up detect.	I	"L"=Hang-up
62	PTT	[PTT] key input. (pull up)	I	–
63	RMUT	RX mute signal to the installed optional unit.	O	"H"=RX mute
64	EXAD	External A/D port.	I	–
65	TEMP	Temperature detect.	I	–
68	RLVIN	RX PLL lock voltage.	I	–
69	BATV	Voltage monitor (divided voltage of "VCC").	I	–
70	TLVIN	TX PLL lock voltage.	I	–
71	RSSI	RSSI signal from the IF IC (M: 5).	I	–
74	XTXD	External data to the RS-232 driver (M: IC26).	O	–
75	XRXD	External data from the RS-232 driver (M: IC26).	I	–
76	TMUT	TX mute signal.	O	"H"=TX mute
77	HINT	DSP IC control signal.	O	–
78	INT1	DSP IC control signal.	O	–
79	HRDY	DSP IC control signal.	O	–
81	HDS1	DSP IC control signal.	O	–
82	HDS2	DSP IC control signal.	O	–
100	RES	CPU reset signal from the reset IC (F: IC501).	O	–
101–108	EXIO1–EXIO8	External data bus line.	I/O	+5 V pull-up
112	POSW	[PWR] key input. (pull-up)	I	–
113	NOIS	Noise detect.	I	"H"=RX signal is absent (squelch close).
114	CSFT	Clock frequency shift signal.	O	–
119	SSO	Serial data to the seri-para converter (M: IC31).	O	–
120	SCK	Clock signal to the seri-para converter (M: IC31).	O	–
121	EXIO9	External data bus line.	I/O	+5 V pull-up
122	DSDA	Serial data to the DAC (M: IC17).	O	–

5-5 CPU (M: IC20) PORT ALLOCATION (continued)

Pin No.	LINE NAME	DESCRIPTION	IN/OUT	CONDITION
123	DAST	Strobe to the DAC (M: IC2).	O	–
125	FMDA	Data from the FRONT CPU (F: IC502).	I	–
126	MFDA	Data to the FRONT CPU (F: IC502).	O	–
127	OPT2	Port for optional unit.	O	–
128	OPT1	Port for optional unit.	I	–
129	OPT3	Port for optional unit.	I	–
131	CSO	Port for optional unit.	O	–
132	CSI	Port for optional unit.	I	–
133	EXOE	Output enable signal to the seri-para converter (M: IC31).	O	–
134	EXST	Strobe to the seri-para converter (M: IC31).	O	–
135	DRES	Reset signal to the DSP IC (M: IC12).	O	–
136	HCS	DSP data line.	I/O	–
138	GPIO2	DSP data line.	I/O	–
139	GPIO1	DSP data line.	I/O	–
140–144	D0–D4	DSP data bus line.	I/O	–

SECTION 6 ADJUSTMENT PROCEDURE

6-1 PREPARATION

REQUIRED EQUIPMENTS

EQUIPMENT	SPECIFICATION	EQUIPMENT	SPECIFICATION
Adjustment Software	"CS-FR5000" (Revision 1.0 or later)	JIG cable	Modified OPC-1122U (USB type) (see the illust below)
Power Supply	Output voltage : 13.6 V DC [FR5000] 13.2 V DC [FR5100] Current capacity : More than 20 A [FR5000] More than 10 A [FR5100]	Attenuator	Power attenuation : 40 dB Capacity : More than 60 W [FR5000] More than 30 W [FR5100]
RF Power Meter (terminated type)	Measuring range : 1–60 W [FR5000] 1–30 W [FR5100] Frequency range : 100–300 MHz Impedance : 50 Ω SWR : Less than 1.2 : 1	Standard Signal Generator (SSG)	Frequency range : 0.1–300 MHz Output level : 0.1 mV to 32 mV (-127 to -17 dBm)
		Audio Generator	Frequency range : 300–3000 Hz Output level : 1–500 mV
Frequency Counter	Frequency range : 0.1–300 MHz Frequency accuracy : ±1 ppm or better Input level : Less than 1 mW	AC Millivoltmeter	Measuring range : 10 mV to 10 V
		Oscilloscope	Frequency range : DC–20 MHz Measuring range : 0.01–20 V
Modulation Analyzer	Frequency range : 30–300 MHz Measuring range : 0 to ±10 kHz	External Speaker	Input impedance : 4 Ω Capacity : More than 5 W

JIG CABLE

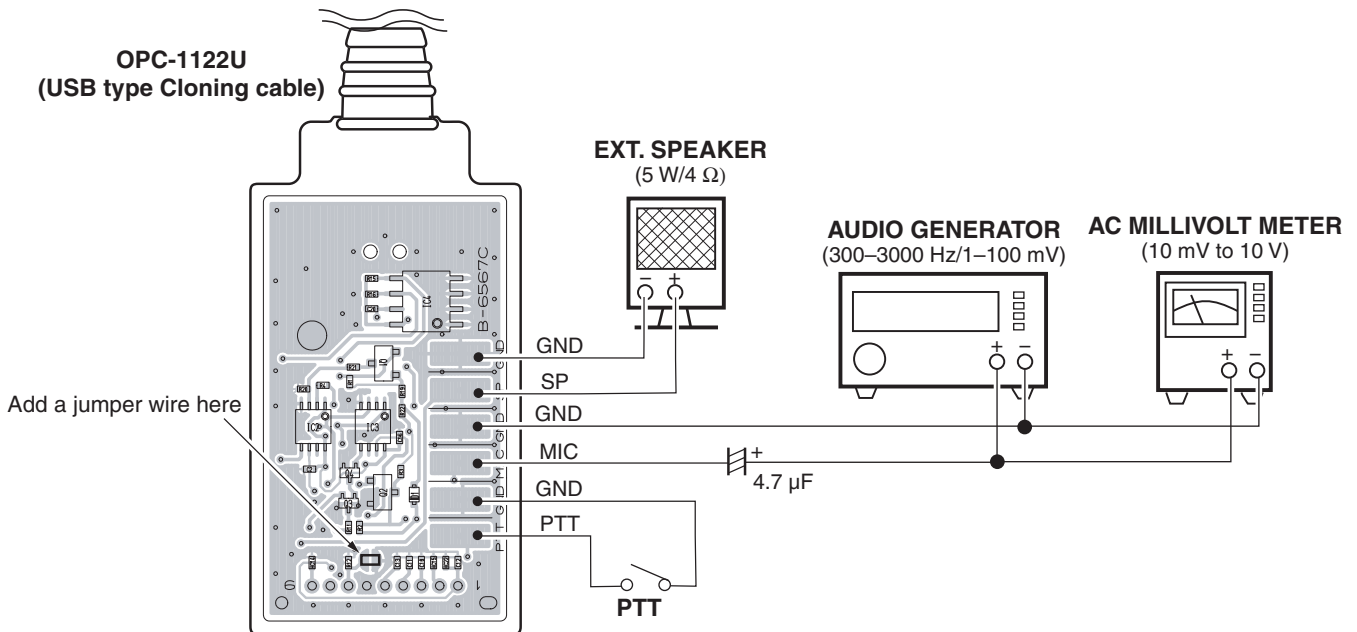

CONNECTION

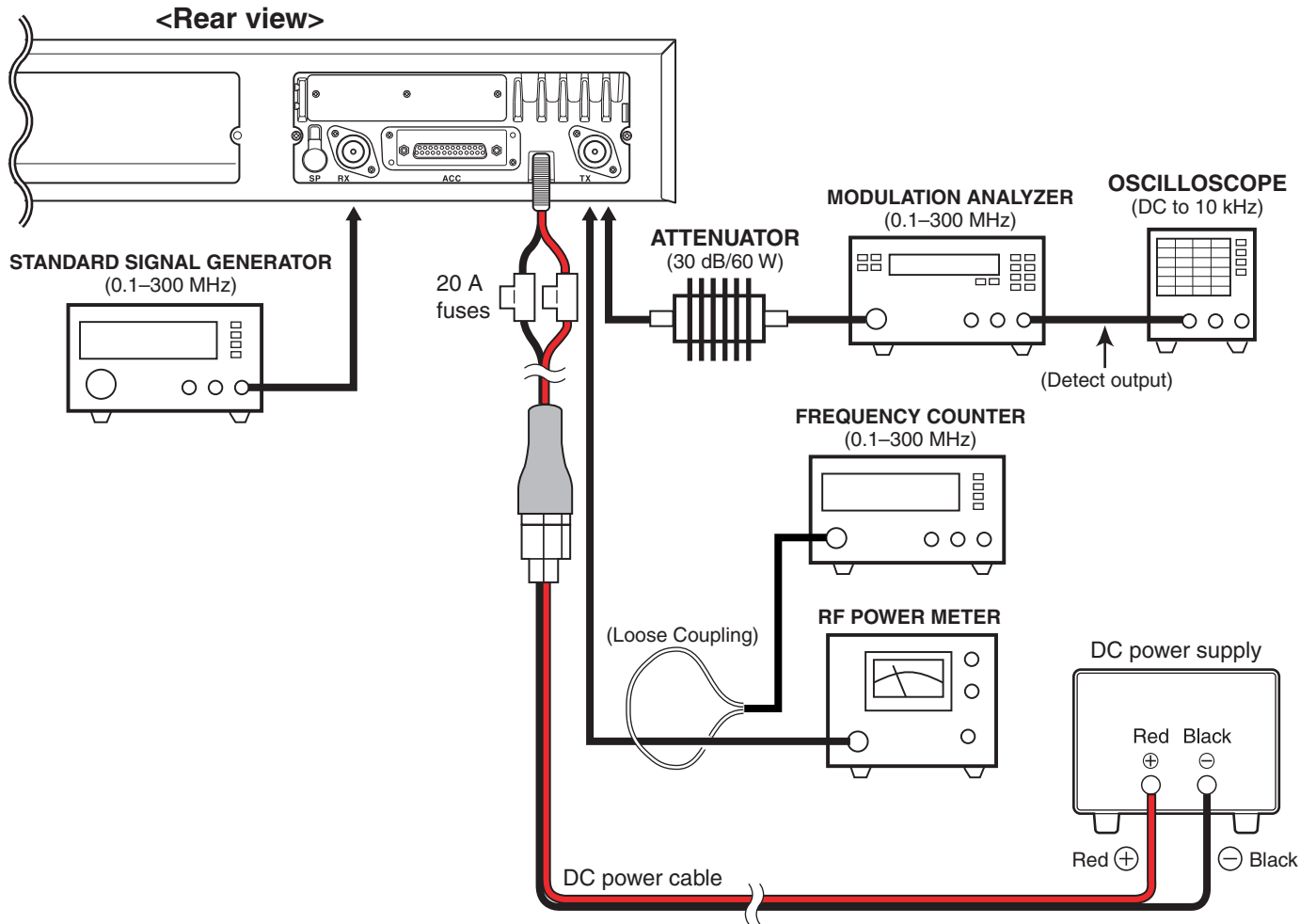

ADJUSTMENT CHANNEL LISTS

Clone the adjust channels into the repeater before starting adjustment. Each channel must be assigned [Frequency], [RF PWR], [CH Type], [TX C. Tone] and [W/N] as below.

• Channel list

Memory CH									
CH	Operation Mode	Frequency (MHz)			Text	TOT			L
		RX	TX	TX Inh		Local Mic	Repeat/EPTT	RF PWR	
1- 1	Simplex	154.900000	<-		RX LV L ADJ			L1	
1- 2	Simplex	173.900000	<-		RX LV H ADJ			L1	
1- 3	Simplex	136.100000	<-		TX LV L ADJ			L1	
1- 4	Simplex	155.000000	<-		TX LV H ADJ			L1	
1- 5	Simplex	136.100000	<-		RX LV L URFY			L1	
1- 6	Simplex	155.000000	<-		RX LV H URFY			L1	
1- 7	Simplex	154.950000	<-		TX LV L URFY			H	
1- 8	Simplex	173.900000	<-		TX LV H URFY			H	
1- 9	Simplex	173.900000	<-		TX Freq			L1	
1- 10	Simplex	136.100000	<-		TX PWR Hi			H	
1- 11	Simplex	136.100000	<-		TX PWR L2			L2	
1- 12	Simplex	136.100000	<-		TX PWR L1			L1	
1- 13	Simplex	145.500000	<-		BAL			L1	
1- 14	Simplex	164.500000	<-		BAL Offset			L1	
1- 15	Simplex	136.100000	<-		DG Dev.			L1	
1- 16	Simplex	142.200000	<-		DG Dev. 0			L1	
1- 17	Simplex	148.600000	<-		DG Dev. 1			L1	
1- 18	Simplex	154.900000	<-		DG Dev. 2			L1	
1- 19	Simplex	155.100000	<-		DG Dev. Offs			L1	
1- 20	Simplex	161.400000	<-		DG Dev. 3			L1	
1- 21	Simplex	167.800000	<-		DG Dev. 4			L1	
1- 22	Simplex	173.900000	<-		DG Dev. 5			L1	
1- 23	Simplex	136.100000	<-		AN Dev. W			L1	
1- 24	Simplex	136.100000	<-		AN Dev. M			L1	
1- 25	Simplex	136.100000	<-		AN Dev. N			L1	
1- 26	Simplex	136.100000	<-		CT/DT Dev.			L1	
1- 27	Simplex	136.100000	<-	i	BPF C ALL			L1	
1- 28	Simplex	173.900000	<-	i	BPF H ALL			L1	
1- 29	Simplex	173.900000	<-	i	RSSI			L1	
1- 30	Simplex	173.900000	<-	i	SQL			L1	

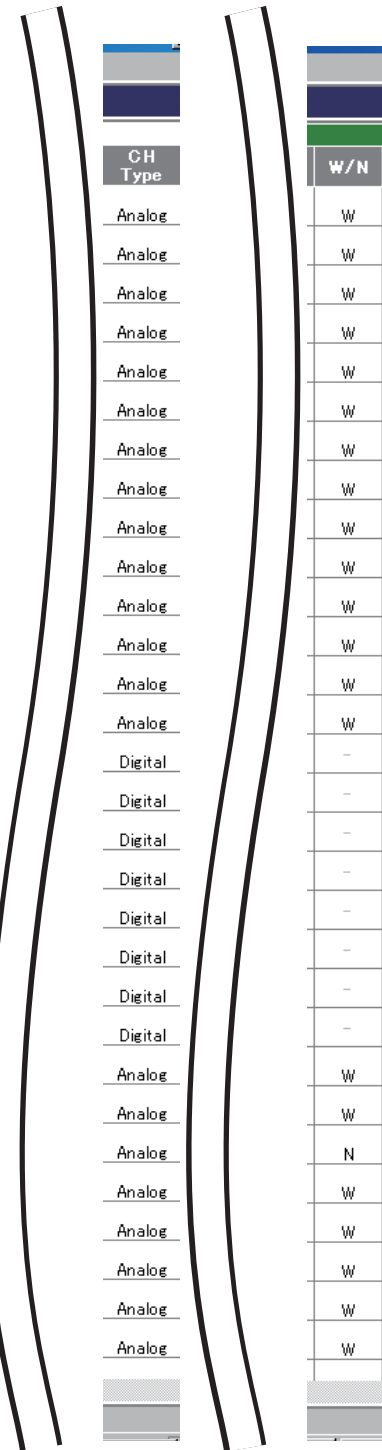

WHOLE PROCEDURE OF THE ADJUSTMENT

- ① Connect the repeater and PC with the JIG cable (see the page 6-2).
- ② Turn the repeater power ON.
- ③ Boot up 'CS-FR5000.'
- ④ Set the [Digital Function] to "Enable."

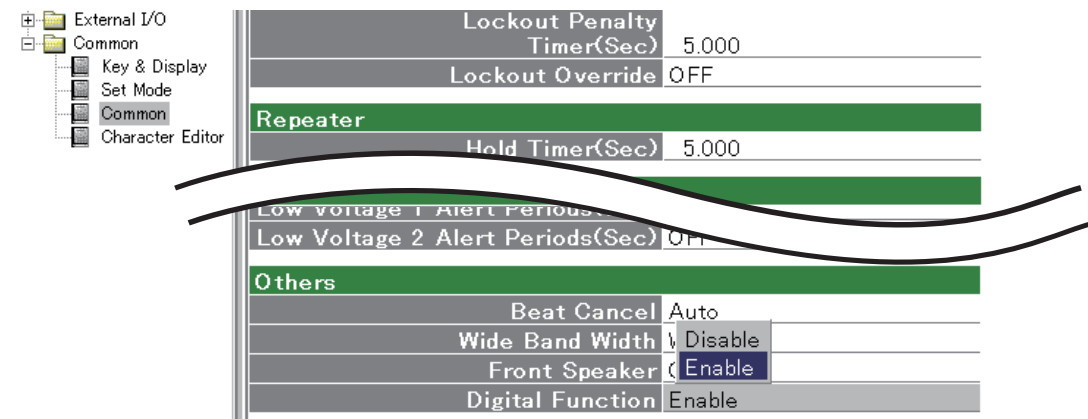

- ⑤ Click  or [Read ← TR] in the [Adjust] menu, then the "Adjust Utility" window (see the page 6-5) appears.

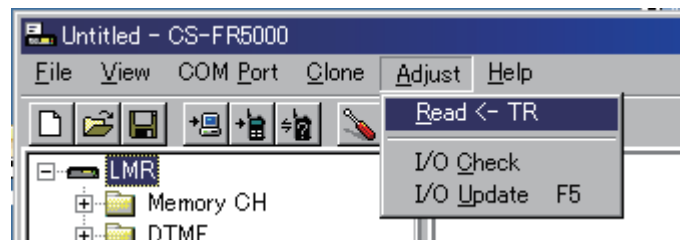

- ⑥ Set or modify adjustment values as specified in the guidances on the pages 6-6 to 6-9.

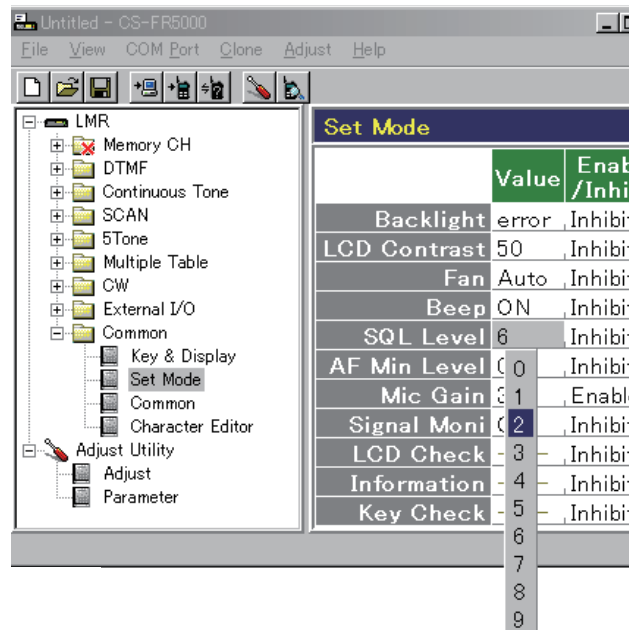

*For [FR5100]:

Set the [Wide Band Width] to "Middle" when adjust "ANALOG DEVIATION" in Middle mode.

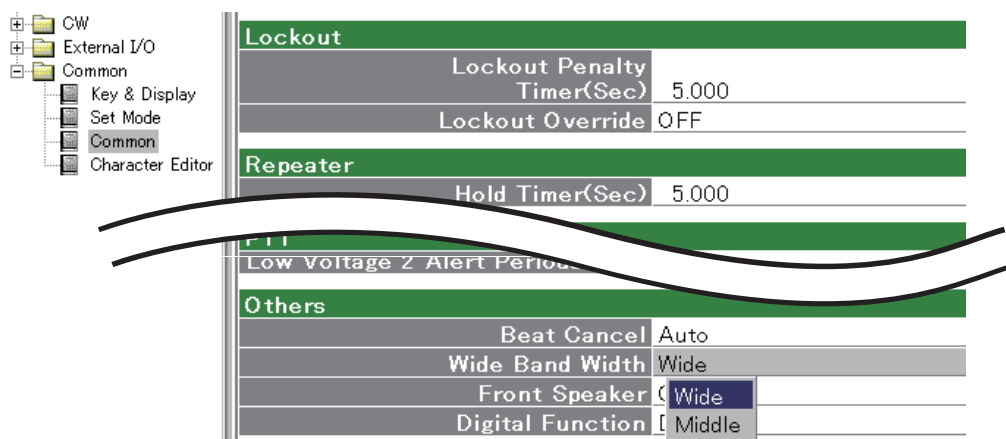

ADJUST UTILITY WINDOW

Adjust Utility			
Setting			
	CH No.	1	Receive Sim
	RX Freq.		
	TX Freq.		
	RF Power.		Low Wide
	W/N		FX=Digital TX=Digital
	CH Type		Digital PNB Digital
Mode setting	TX Mode	17	
	RX Mode	2	
	AF Volume	0	[-----]
Adjust			
TX output power	Power (H)	208	[-----]
	Power (L2)	150	[-----]
	Power (L1)	76	[-----]
Analog deviation	MOD (Wide)	139	[-----]
	MOD (Mid)	144	[-----]
	MOD (Narrow)	65	[-----]
	MOD (Digital)	105	[-----]
CTCSS/DTCS deviation	CTCSS/DTCS	137	[-----]
	S.Tone	75	[-----]
Squelch	SQL	50	[---]
Expert			
TX frequency	RX REF	178	[-----]
	TX REF	126	[-----]
Lock volatge (Preset)	RX LVA L	80	[-----] [Enter] to Sweep
	RX LVA H	62	[-----] [Enter] to Sweep
	TX LVA L	166	[-----] [Enter] to Sweep
	TX LVA H	105	[-----] [Enter] to Sweep
Lock volatge (Adjustment)	LV (RX L)	36	0.70V
	LV (RX H)	36	0.70V
	LV (TX L)	36	0.70V
	LV (TX H)	36	0.70V
S-meter	RSSI	74	[Enter] to Capture
Modulation balance	BAL	174	[-----]
	BAL Offset (High)	0	[-----]
Modulation balance (High)	PWR Hi Slant Band 0	0	[-----]
	PWR Hi Slant Band 1	3	[-----]
	PWR Hi Slant Band 2	4	[-----]
	PWR Hi Slant Band 3	25	[-----]
	PWR Hi Slant Band 4	8	[-----]
	PWR Hi Slant Band 5	6	[-----]
	PWR Hi Slant Band 6	0	[-----]
	PWR L2 Slant Band 0	0	[-----]
	PWR L2 Slant Band 1	4	[-----]
	PWR L2 Slant Band 2	4	[-----]
	PWR L2 Slant Band 3	17	[-----]
	PWR L2 Slant Band 4	8	[-----]
	PWR L2 Slant Band 5	6	[-----]
	PWR L2 Slant Band 6	0	[-----]
	PWR L1 Slant Band 0	0	[-----]
	PWR L1 Slant Band 1	0	[-----]
	PWR L1 Slant Band 2	2	[-----]
	PWR L1 Slant Band 3	14	[-----]
PWR L1 Slant Band 4	6	[-----]	
PWR L1 Slant Band 5	4	[-----]	
PWR L1 Slant Band 6	0	[-----]	
Digital deviation	MOD Slant Band 0	0	[-----]
	MOD Slant Band 1	-9	[-----]
	MOD Slant Band 2	-13	[-----]
	MOD Slant Band 3	-2	[-----]
	MOD Slant Band 4	-5	[-----]
	MOD Slant Band 5	2	[-----]
	MOD Slant Band 6	0	[-----]
	MOD Offset (High)	0	[-----]
Receive sensitivity (Band center)	BPF C ALL		[Enter] to Sweep
	BPF T1 C	4	[-----] [Enter] to Sweep
	BPF T2 C	25	[-----] [Enter] to Sweep
Receive sensitivity (Band high)	BPF L ALL		[Enter] to Sweep
	BPF T1 L	80	[-----] [Enter] to Sweep
	BPF T2 L	45	[-----] [Enter] to Sweep
	BPF H ALL		[Enter] to Sweep
	BPF T1 H	69	[-----] [Enter] to Sweep
	BPF T2 H	53	[-----] [Enter] to Sweep

6-2 FREQUENCY ADJUSTMENT

- 1) Select an adjustment item using cursor or [↑] / [↓] keys of the PC's keyboard.
- 2) Set or modify the adjustment value as specified using [←] / [→] keys of the PC's keyboard, then push the [ENTER] key.

ADJUSTMENT	ADJUSTMENT CONDITION	OPERATION	ADJUSTMENT ITEM	VALUE	
PLL LOCK VOLTAGE -Preparation-	1	1) Connect an RF power meter to the TX antenna. 2) Set the preset adjustment value on the adjustment utility window.	[LV (RX L)]	161 [3.15V]	
			[LV (RX H)]	153 [3.00V]	
			[LV (TX L)]	51 [1.0V]	
			[LV (TX H)]	36 [0.7V]	
-Adjust-RX (Band center)	2 • CH. : 1-1 • Receiving	• Select the item [RX LVA L], then push the [ENTER] key.	[RX LVA L]	(Automatic adjustment)	
RX (Band high)	3 • CH. : 1-2 • Receiving	• Select the item [RX LVA H], then push the [ENTER] key.	[RX LVA H]		
TX (Band low)	4 • CH. : 1-3 • Transmitting	• Select the item [TX LVA L], then push the [ENTER] key.	[TX LVA L]		
TX (Band center)	5 • CH. : 1-4 • Transmitting	• Select the item [TX LVA H], then push the [ENTER] key.	[TX LVA H]		
LOCK VOLTAGE VERIFY	1 • CH. : 1-5 • Receiving	• Verify the lock voltage at each channels on the [RX LIVIN] item on the "I/O Check window" as below.	[RX LIVIN] (I/O Check window)	0.5–1.5 V (Verify)	
RX (Band low)					
RX (Band center)					2 • CH. : 1-6 • Receiving
TX (Band center)					3 • CH. : 1-7 • Transmitting
TX (Band high)	4 • CH. : 1-8 • Transmitting	• Verify the lock voltage at each channels on the [TX LIVIN] item on the "I/O Check window" as below.	[TX LIVIN] (I/O Check window)	3.0–4.5 V (Verify)	
TX FREQUENCY	1	1) Set the item [TX Mode] to "1." 2) Connect an RF power meter to the TX antenna.	[TX Mode]	"1"	
	2 • CH. : 1-9 • Transmitting	1) Adjust the frequency using [←] / [→] keys of the PC's keyboard. 2) Push the [ENTER] key to store the adjust value.	[TX REF]	173.9000 MHz	

• I/O CHECK WINDOW

I/O Check			
Input	Dec	Hex	Data
VIN	180	B4	14.12V
TEMPS	100	06	28.21°C
RX LIVIN	116	74	2.27V
TX LIVIN	219	DB	4.29V
SD	28	1C	0.53V
Output	Dec	Hex	Data
BPF T1	165	A5	3.24V
BPF T2	253	FD	4.96V
RF POWER	0	0	0.00V
RX LVA	165	A5	3.24V
TX LVA	145	91	2.84V
RX REF	77	4D	1.51V
TX REF	126	7E	2.47V
MOD BAL	0	0	0.00V
DEV	43	2B	0.84V
FANV	255	FF	5.00V

Lock voltage verify

*The above voltages are just an example.

6-3 TRANSMIT ADJUSTMENT

1) Select an adjustment item using cursor or [↑] / [↓] keys of the PC's keyboard.

2) Set or modify the adjustment value as specified using [←] / [→] keys of the PC's keyboard, then push the [ENTER] key.

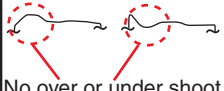
ADJUSTMENT		ADJUSTMENT CONDITION	OPERATION	ADJUSTMENT ITEM	VALUE
TX Output Power -Preparation-	1	—	• Connect an RF power meter to the TX antenna connector.	—	—
-Adjust- (Hi Power)	2	• CH. : 1-10 • Transmitting	1) Adjust the TX output power using [←] / [→] keys of the PC's keyboard. 2) Push the [ENTER] key to store the adjust value.	[Power(Hi)]	50 W [FR5000] 25 W [FR5100]
(L2 Power)	3	• CH. : 1-11 • Transmitting		[Power(L2)]	25 W [FR5000] 10 W [FR5100]
(L1 Power)	4	• CH. : 1-12 • Transmitting		[Power(L1)]	5 W [FR5000] 2.5 W [FR5100]
MODULATION BALANCE -Preparation-	1	• Connect a Modulation Analyzer to the TX antenna connector through an attenuator.		• Set the Modulation Analyzer as; HPF : OFF LPF : 20 kHz De-emphasis : OFF Detector : (P-P)/2	—
	2	—	• Set the item [TX Mode] to "2."	[TX Mode]	"2"
-Adjust- (TX VCO 1)	3	• CH. : 1-13 • Transmitting	1) Adjust the wave form using [←] / [→] keys of the PC's keyboard. 2) Push the [ENTER] key to store the adjust value.	[BAL]	As flat as possible. 
(TX VCO 2)	4	• CH. : 1-14 • Transmitting		[BAL Offset (High)]	 No over or under shoot.
DIGITAL DEVIATION -Preparation-	1	—	• Set the item [TX Mode] to "16."	[TX Mode]	"16"
	2	• Connect a Modulation Analyzer to the TX antenna connector through an attenuator.	• Set the Modulation Analyzer as; HPF : OFF LPF : 20 kHz De-emphasis : OFF Detector : (P-P)/2	—	—
-Adjust- (Band 1)	3	• CH. : 1-15 • Transmitting	1) Adjust the deviation using [←] / [→] keys of the PC's keyboard. 2) Push the [ENTER] key to store the adjust value.	[MOD (Digital)]	±1.39–1.43 kHz
(Band 2)	4	• CH. : 1-16 • Transmitting		[MOD Slant Band 0]	
(Band 3)	5	• CH. : 1-17 • Transmitting		[MOD Slant Band 1]	
(Band 4)	6	• CH. : 1-18 • Transmitting		[MOD Slant Band 2]	
(Band 5)	7	• CH. : 1-19 • Transmitting		[MOD Offset (High)]	
(Band 6)	8	• CH. : 1-20 • Transmitting		[MOD Slant Band 3]	
(Band 7)	9	• CH. : 1-21 • Transmitting		[MOD Slant Band 4]	
(Band 8)	10	• CH. : 1-22 • Transmitting		[MOD Slant Band 5]	

6-3 TRANSMIT ADJUSTMENT (continued)

1) Select an adjustment item using cursor or [↑] / [↓] keys of the PC's keyboard.

2) Set or modify the adjustment value as specified using [←] / [→] keys of the PC's keyboard, then push the [ENTER] key.

ADJUSTMENT	ADJUSTMENT CONDITION	OPERATION	ADJUSTMENT ITEM	VALUE
ANALOG DEVIATION -Preparation-	1	–	• Set the item [TX Mode] to "1."	[TX Mode] "1"
	2	• Connect a Modulation Analyzer to the TX antenna connector through an attenuator.	• Set the Modulation Analyzer as; HPF : OFF LPF : 20 kHz De-emphasis : OFF Detector : (P-P)/2	– –
	3	• Connect an Audio Generator to the MIC line through the JIG cable.	• Set the Audio Generator as; Modulation : 1050 Hz Level : 40 mVrms Waveform : Sine wave	– –
-Adjust- (Wide)	4	• CH. : 1-23 • Transmitting	1) Adjust the deviation using [←] / [→] keys of the PC's keyboard. 2) Push the [ENTER] key to store the adjust value.	[MOD (Wide)] ±4.05–4.15 kHz
(Middle) <[FR5100] only>	5	• CH. : 1-24 • [Wide Band Width] : "Middle" (see the page 6-4) • Transmitting		[MOD (Middle)] ±3.15–3.25 kHz
(Narrow)	6	• CH. : 1-25 • Transmitting		[MOD (Narrow)] ±2.05–2.15 kHz
CTCSS/DTCS DEVIATION -Preparation-	1	–	• Set the item [TX Mode] to "3."	[TX Mode] "3"
-Adjust-	2	• CH. : 1-26 • Transmitting	1) Adjust the deviation using [←] / [→] keys of the PC's keyboard. 2) Push the [ENTER] key to store the adjust value.	[CTCSS] ±0.68–0.72 kHz

6-4 RECEIVE ADJUSTMENT

1) Select an adjustment item using cursor or [↑] / [↓] keys of the PC's keyboard.

2) Set or modify the adjustment value as specified using [←] / [→] keys of the PC's keyboard, then push the [ENTER] key.

ADJUSTMENT	ADJUSTMENT CONDITION	OPERATION	ADJUSTMENT ITEM/POINT	VALUE
RECEIVE SENSITIVITY -Preparation-	1	–	• Set the item [RX Mode] to "1."	[RX Mode] "1"
	2	• Connect an SSG to the RX antenna connector.	• Set the SSG as; Level : +20 dBμ Modulation : 1 kHz Deviation : 3.5 kHz	– –
-Adjust- (Band center)	3	• CH. : 1-27 • Receiving	1) Set the SSG as; Frequency : 136.100 MHz 2) Select the item [BPF C ALL], then push the [ENTER] key.	[BPF C ALL] (Automatic adjustment)
(Band high) <[FR5000] only>	4	• CH. : 1-28 • Receiving	1) Set the SSG as; Frequency : 173.900 MHz 2) Select the item [BPF H ALL], then push the [ENTER] key.	[BPF H ALL]

6-4 RECEIVE ADJUSTMENT (continued)

1) Select an adjustment item using cursor or [↑] / [↓] keys of the PC's keyboard.

2) Set or modify the adjustment value as specified using [←] / [→] keys of the PC's keyboard, then push the [ENTER] key.

ADJUSTMENT	ADJUSTMENT CONDITION	OPERATION	ADJUSTMENT ITEM/POINT	VALUE	
S-METER -Preparation-	NOTE: "RECEIVE SENSITIVITY" MUST be adjusted before "S-METER." When "RECEIVE SENSITIVITY" is re-adjusted, "S-METER" MUST be re-adjusted too.				
	1	<ul style="list-style-type: none"> Connect an SSG to the RX antenna connector. 	<ul style="list-style-type: none"> Set the SSG as; <ul style="list-style-type: none"> Frequency : 173.900 MHz Modulation : 1 kHz Deviation : 3.5 kHz 	-	-
-Adjust- (S3 level)	2	<ul style="list-style-type: none"> CH. : 1-29 Receiving 	1) Set the SSG as; <ul style="list-style-type: none"> Level : +23 dBμ 2) Select the item [RSSI S3 Level] , then push the [ENTER] key to store the adjust value.	[RSSI S3 Level]	(Automatic adjustment)
(S1 level)	3	<ul style="list-style-type: none"> CH. : 1-29 Receiving 	1) Set the SSG as; <ul style="list-style-type: none"> Level : -7 dBμ 2) Select the item [RSSI S1 Level] , then push the [ENTER] key, to store the adjust value.	[RSSI S1 Level]	(Automatic adjustment)
SQUELCH -Preparation-	1	-	<ul style="list-style-type: none"> Set the item [SQL Level] to "2." 	[SQL Level]	"2"
	2	<ul style="list-style-type: none"> Connect an SSG to the RX antenna connector. 	<ul style="list-style-type: none"> Set the SSG as; <ul style="list-style-type: none"> Frequency : 173.900 MHz Modulation : 1 kHz Deviation : 3.5 kHz Level : -14 dBμ 	-	-
-Adjust-	3	<ul style="list-style-type: none"> CH. : 1-30 Receiving 	1) Decrease the adjustment value [SQL] to close the squelch once, then increase the value to open the squelch. 2) Select the item [SQL] , then push the [ENTER] key to store the adjust value.	[SQL]	(Automatic adjustment)

[FRONT UNIT]

REF NO.	ORDER NO.	DESCRIPTION	M.	H/V LOCATION
S506	2250000511	ECR RH70N1037E20-13F-2781		
SP501	2510001221	SP C052SB500-14		
W501	8900011800	CBL OPC-1199		
W502	8900017540	CBL OPC-1785		
EP501	8930065150	LCT SRCN-2781-SP-N-W (SHJ)		
EP503	6910019600	SCR LM-5		
EP504	6910019610	SCR LM-7 (SPACER)		

[MAIN UNIT]

REF NO.	ORDER NO.	DESCRIPTION	M.	H/V LOCATION
IC1	1110005330	S.IC NJM12904V-TE1-#ZZZB	T	58.1/71.4
IC2	1110007290	S.IC AK2330P-L	B	58.7/56.1
IC3	1130010100	S.IC LMX2352TMX/NOPB	B	120.2/43.9
IC4	1130010100	S.IC LMX2352TMX/NOPB	B	28/78.8
IC5	1110003491	S.IC TA31136FNG (D,EL)	B	70.4/82.5
IC7	1110007280	S.IC NJM2716F-TE1-#ZZZB	B	56.8/46.4
IC8	1130012910	S.IC AK4554VTP-E2/P	B	36.2/59.9
IC9	1190002080	S.IC AD7476ARTZ-500RL7	B	49.6/46.4
IC10	1130013040	S.IC TC7WBD125AFK (T5L,F)	B	46.6/49.2
IC11	1110006230	S.IC NJM2711F-TE1-#ZZZB	B	53.1/35
IC12	1140013290	S.IC TMS320VC5509AZHH	B	33.3/37.8
IC13	1180002590	S.REG XC6204B332MR	T	80.9/21.3
IC14	1180003270	S.REG R1114Q161D-TR-F	T	84.4/21.4
IC15	1180002590	S.REG XC6204B332MR	T	87.8/21.3
IC17	1190001340	S.IC M62334FP 600C	T	67.3/61.7
IC18	1110005771	S.IC S-80942CNMC-G9CT2G	T	41.2/52.8
IC19	1180003210	S.REG NJM2831F10	B	111/26.2
IC20	1140014550	S.IC HD64F2506RFC26DV	T	33.5/37.6
IC21	1140012950	S.IC 24LC512T-I/SM	T	59.1/21.8
IC22	1150002042	IC RA30H1317M-121 [EUR-01]		
	1150002073	IC RA60H1317M-125 [USA-01], [EXP-01]		
IC23	1110002751	S.IC TA75S01F (TE85R,F)	T	141.7/125.1
IC25	1130008561	S.IC TC75S51F (TE85L,F)	B	29/16.3
IC26	1120003070	S.IC MAX3232EIPWR	T	42.7/70
IC27	1180001251	S.IC TA7808F (TE16L,Q)	T	114.4/85
IC28	1110003091	IC LA4425A-E		
IC29	1110002751	S.IC TA75S01F (TE85R,F)	T	12/123.1
IC30	1110003390	S.IC AN8005M-(E1)	T	98.3/91.4
IC31	1130011760	S.IC CD4094BPWR	T	8.1/45.2
IC32	1130013360	S.IC AT25F2048N-10SU-2.7SL383	B	8.9/36.1
IC34	1110005340	S.IC NJM12902V-TE1-#ZZZB	B	12.2/58.2
IC35	1140013200	S.IC CD4053BPWR	B	20.6/58.2
IC36	1110005330	S.IC NJM12904V-TE1-#ZZZB	B	27.8/55.4
IC37	1120002830	S.IC NJM2125F-TE1-#FZZB	T	56.6/66.7
IC38	1110006380	S.IC LM2904PWR	T	114.1/23.8
IC39	1180001071	S.IC TA7805F (TE16L,Q)	T	101.2/24.3
IC40	1110005330	S.IC NJM12904V-TE1-#ZZZB	B	50.6/57.2
IC41	1180001251	S.IC TA7808F (TE16L,Q)	B	132/16.7
Q1	1590003230	S.TR UNR9113J-(TX)	B	53.4/79.7
Q2	1530002851	S.TR 2SC4116-BL (TE85R,F)	B	34.9/77.7
Q3	1560001360	S.FET 2SK3019 TL	B	66.4/76.3
Q5	1560000541	S.FET 2SK880-Y (T5RICOM,F)	B	35.7/107.1
Q7	1530002601	S.TR 2SC4215-O (TE85R,F)	B	73/92.9
Q8	1560000541	S.FET 2SK880-Y (T5RICOM,F)	B	89.5/46
Q9	1560001360	S.FET 2SK3019 TL	B	39.6/103.6
Q10	1530002851	S.TR 2SC4116-BL (TE85R,F)	B	89.5/43.5
Q11	1530002851	S.TR 2SC4116-BL (TE85R,F)	B	30.6/104.2
Q12	1590003230	S.TR UNR9113J-(TX)	B	66.1/100.3
Q13	1530002851	S.TR 2SC4116-BL (TE85R,F)	B	84.7/43.5
Q14	1530002851	S.TR 2SC4116-BL (TE85R,F)	B	30.6/107.1
Q15	1530002851	S.TR 2SC4116-BL (TE85R,F)	B	96.9/44.4
Q16	1530002851	S.TR 2SC4116-BL (TE85R,F)	T	35.2/108.3
Q19	1530002601	S.TR 2SC4215-O (TE85R,F)	B	63.2/106.8
Q20	1530002920	S.TR 2SC4226-T1 R25	B	39.9/123.1
Q21	1530002920	S.TR 2SC4226-T1 R25	B	39.6/114.5
Q22	1530002920	S.TR 2SC4226-T1 R25	B	95.2/64.3
Q23	1530002920	S.TR 2SC4226-T1 R25	B	95.2/54.5
Q24	1530003311	S.TR 2SC5107-O (TE85R,F)	B	100.6/58.6
Q25	1530003311	S.TR 2SC5107-O (TE85R,F)	B	44.9/117.4
Q26	1590001400	S.TR XP1214 (TX)	B	40.5/117.8
Q27	1590001400	S.TR XP1214 (TX)	B	96/59.6
Q28	1590003290	S.TR UNR9213J-(TX)	B	93.3/59.6
Q29	1590003290	S.TR UNR9213J-(TX)	T	57.2/41.9
Q30	1590003290	S.TR UNR9213J-(TX)	B	37.8/117.8
Q31	1590003230	S.TR UNR9113J-(TX)	T	57.2/39.8
Q32	1530003311	S.TR 2SC5107-O (TE85R,F)	B	46.2/111.7
Q33	1530003311	S.TR 2SC5107-O (TE85R,F)	B	101.9/53
Q34	1530003311	S.TR 2SC5107-O (TE85R,F)	B	46.2/123.1
Q35	1530003311	S.TR 2SC5107-O (TE85R,F)	B	101.9/64.4
Q36	1580000731	S.FET 3SK293 (TE85L,F)	B	48.3/136.6
Q37	1530003311	S.TR 2SC5107-O (TE85R,F)	B	132.4/84.5
Q38	1530002680	S.TR 2SC3357-T1	B	139.5/86
Q39	1560000841	S.FET 2SK1829 (TE85R,F)	B	54.2/142.5
Q40	1590001190	S.TR XP6501-(TX) .AB	T	101.6/87.4
Q41	1520000460	S.TR 2SB1132 T100 R	T	101.6/82.8
Q42	1590003290	S.TR UNR9213J-(TX)	T	13.3/67.6
Q43	1590003290	S.TR UNR9213J-(TX)	T	137.3/125
Q44	1590003290	S.TR UNR9213J-(TX)	T	114.3/80.1
Q45	1540000550	S.TR 2SD1664 T100Q	T	118.4/75.2
Q46	1530002851	S.TR 2SC4116-BL (TE85R,F)	T	137.3/120.2
Q48	1510000920	S.TR 2SA1577 T106 Q	T	101.5/77.8
Q49	1590003290	S.TR UNR9213J-(TX)	T	102.2/73.7
Q52	1590003290	S.TR UNR9213J-(TX)	T	10.9/131.6
Q53	1590003290	S.TR UNR9213J-(TX)	T	10.9/129.6
Q56	1590003321	S.FET TPC6103 (TE85L,F)	T	7.6/132.6
Q57	1550000100	S.FET 2SJ377 (TE16L1,NQ)	T	123.3/99.6
Q58	1590003290	S.TR UNR9213J-(TX)	T	129.4/102.2
Q59	1590000990	S.TR DTC363EK T146	T	7.6/127.6
Q61	1530002851	S.TR 2SC4116-BL (TE85R,F)	T	6.8/118.4
Q62	1540000441	S.TR 2SD1619T-TD-E	T	118.4/18.6
Q63	1560000990	S.FET PMBFJ310	B	66.3/110
Q64	1560000990	S.FET PMBFJ310	B	63.4/110
Q65	1530003311	S.TR 2SC5107-O (TE85R,F)	B	59.6/123.7
Q66	1590003290	S.TR UNR9213J-(TX)	B	94.9/4.7
Q67	1590003290	S.TR UNR9213J-(TX)	B	124.9/4.7
Q68	1590003290	S.TR UNR9213J-(TX)	B	109.9/4.7
Q69	1590003290	S.TR UNR9213J-(TX)	T	9.5/53.3
Q70	1590003230	S.TR UNR9113J-(TX)	T	9.5/51
Q71	1560000990	S.FET PMBFJ310	B	60.5/110
Q72	1530002851	S.TR 2SC4116-BL (TE85R,F)	B	107/26.3

M.=Mounted side (T: Mounted on the Top side, B: Mounted on the Bottom side) S.=Surface mount

SECTION 8

MECHANICAL PARTS

[CHASSIS PARTS]

REF NO.	ORDER NO.	DESCRIPTION	QTY.
MP1	8810003361	SETSCREW (C) 3X6 ZC3	4
MP2	8810003361	SETSCREW (C) 3X6 ZC3	1
MP3	8110009330	3063 U-COVER	1
MP4	8110009340	3063 BOTTOM COVER	1
MP5	8930073980	3063 ANGLE	2
MP6	8930073990	3063 CENTER ANGLE	1
MP7	8810005771	SCREW BIH M3X8 ZK3	11
MP9	8810009061	SCREW M3X6 ZK3	7
MP10	8810008661	SCREW BT B0 3X8 NI-ZC3 (BT)	2

[FRONT UNIT]

REF NO.	ORDER NO.	DESCRIPTION	QTY.
J501*	6510019121	S8B-PH-SM4-TB (LF) (SN)	1
J502*	6510019121	S8B-PH-SM4-TB (LF) (SN)	1
J503*	6450002210	3017-8821	1
J504*	6510014961	B2B-ZR-SM4-TF (LF) (SN)	1
DS500	5030002811	L4-0013TVY-2	1
DS501	5040002710	EMPG3338S	1
DS502	5040002720	EMVR3338S	1
DS503	5040002710	EMPG3338S	1
DS504	5040002720	EMVR3338S	1
DS511	5040002150	VRPG3349S-734	1
DS512	5040002150	VRPG3349S-734	1
S506	2250000511	RH70N1037E20-13F-2781	1
SP501	2510001221	C052SB500-14	1
W501	8900011800	OPC-1199	1
W502	8900017540	OPC-1785 (Incl. MP521, MP522)	1
EP501	8930065150	SRCN-2781-SP-N-W	2
EP503	6910019600	LM-5	2
EP504	6910019610	LM-7 (SPACER)	4
MP501	8930064260	2781 LCD HOLDER	1
MP502	8210021190	2781 REFLECTOR	1
MP503	8610012160	KNOB N-324 (Incl. MP505)	1
MP504	8610012150	KNOB N-325 (Incl. MP506)	1
MP505	8610007420	KNOB SPRING NO.6601	1
MP506	8610007510	KNOB SPRING NO.7800	1
MP507	8930064220	2781 KNOB RUBBER	1
MP508	8930075200	HIMELON SHEET (CY)	2
MP510	8930059000	2601 SP NET	1
MP511	8210024400	3063 FRONT PANEL	1
MP512	8930074161	3063 FRONT PLATE-1	1
MP513	8310070870	3063 WINDOW PLATE	1
MP514	8210024431	3063 M-PANEL-1	1
MP515	8930074000	3063 SP ANGLE	1
MP516	8110009350	3063 FRONT COVER	1
MP517	8930073820	3063 FRONT KEY	1
MP518	8930073911	3063 M-COVER-1	1
MP519	8930074020	3063 KNOB RUBBER	1
MP520	8930075010	3063 A-PACKING	1
MP521	8930074010	3063 CODE RUBBER	1
MP522	8110009090	2854 A-MODULER COVER	1
MP529	8810008661	SCREW BT B0 3X8 NI-ZC3 (BT)	6
MP530	8810008661	SCREW BT B0 3X8 NI-ZC3 (BT)	2
MP531	8810008661	SCREW BT B0 3X8 NI-ZC3 (BT)	4
MP532	8810008661	SCREW BT B0 3X8 NI-ZC3 (BT)	6
MP533	8810008661	SCREW BT B0 3X8 NI-ZC3 (BT)	5

[CONNECT UNIT]

REF NO.	ORDER NO.	DESCRIPTION	QTY.
J601*	6510026290	IIMS A-9631S-28Y921	1
J602*	6510023210	CD6125SA1J0	1
S1*	2260003070	MINISMDC150F/24	1
W601	8900017500	OPC-1852	1

[MAIN UNIT]

REF NO.	ORDER NO.	DESCRIPTION	QTY.
J1*	6510025220	AXK540145J	1
J2*	6510023091	20FLT-SM2-TB (LF) (SN)	1
J4*	6510023511	28FLT-SM2-TB (LF) (SN)	1
J5*	6510023110	3008L-8P8C	1
J6*	6450000140	HSJ0807-01-010	1
J8*	6510023091	20FLT-SM2-TB (LF) (SN)	1
J9*	6510019371	B3B-ZR-SM4-TF (LF) (SN)	1
J10	6510004910	NR-DSE-01	1
J11	6510004910	NR-DSE-01	1
MF1	2710000870	AFB0512HB-F00	1
W1*	7120000470	ERDS2T0	1
W2*	7120000470	ERDS2T0	1
W4	8900017520	OPC-1783	1
MP1	8510018070	2979 VCO CASE	1
MP2*	8510018060	2979 VCO COVER	1
MP3	8510018070	2979 VCO CASE	1
MP4*	8510018060	2979 VCO COVER	1
MP5	8210024440	3063 SUB M-PANEL	1
MP6	8310070880	3063 S-LED PLATE	1
MP7	8930073920	3063 SP COVER	1
MP8	8010020980	3063 CHASSIS	1
MP9	8110009360	3063 SU-COVER	1
MP10	8110009370	3063 SL-COVER	1
MP11	8930074300	3063 PC PLATE	1
MP12	8930074180	O-RING (BR)	1
MP13	8930075020	3063 B-PACKING	1
MP14	8930075030	3063 C-PACKING	1
MP15	8930073930	3063 SP RUBBER	1
MP17	8930062160	HIMELON SHEET (CL)	1
MP18	8930070921	2979 D-SUB PLATE-1	1
MP19	8930058990	SHIELD SPONGE (V)	1
MP20*	8510015660	2681 F-SHIELD PLATE	1
MP21	8930048550	2177 CLIP	1
MP22	8810008451	SCREW BIH M4X8 ZK3	4
MP23	8930075080	DUST CAP HR25F	1
MP24	8810009611	SCREW M2.6X6 ZK3	8
MP25	8810009611	SCREW M2.6X6 ZK3	9
MP26	8810010780	SCREW BT B0 3X20NI-ZK3 (BT)	4
MP27	8810008661	SCREW BT B0 3X8 NI-ZC3 (BT)	19
MP28	8810008661	SCREW BT B0 3X8 NI-ZC3 (BT)	2
MP29	8810008661	SCREW BT B0 3X8 NI-ZC3 (BT)	1
MP30	8810008661	SCREW BT B0 3X8 NI-ZC3 (BT)	2
MP31	8810008661	SCREW BT B0 3X8 NI-ZC3 (BT)	3
MP32	8810008661	SCREW BT B0 3X8 NI-ZC3 (BT)	4
MP33*	8510018780	3063 ANT CASE	2
MP35	8810003361	SETSCREW (C) 3X6 ZC3	2
MP37	8510018790	3063 VCO SHIELD	1
MP38*	8510018820	3063 SHIELD PLATE	1
MP40*	8930050472	SHIELD SPONGE (A)-2	1
MP41*	8930050472	SHIELD SPONGE (A)-2	1
MP42*	8930050472	SHIELD SPONGE (A)-2	1

[ACCESSORIES]

REF NO.	ORDER NO.	DESCRIPTION	QTY.
W1	8900017530	OPC-1784	1
MP1	8930074310	3063 HANDLE	2
MP2	8930074320	3063 H-SPACER	4
MP3	8810010740	SETSCREW (C) 4X12 ZK3	4
MP4	8310071490	3063 KEY SEAL	1

*: Refer to "BOARD LAYOUTS" for the location.

Screw abbreviations A, B0, BT: Self-tapping PH: Pan head ZK: Black NI-ZU: Nickel-Zinc SUS: Stainless

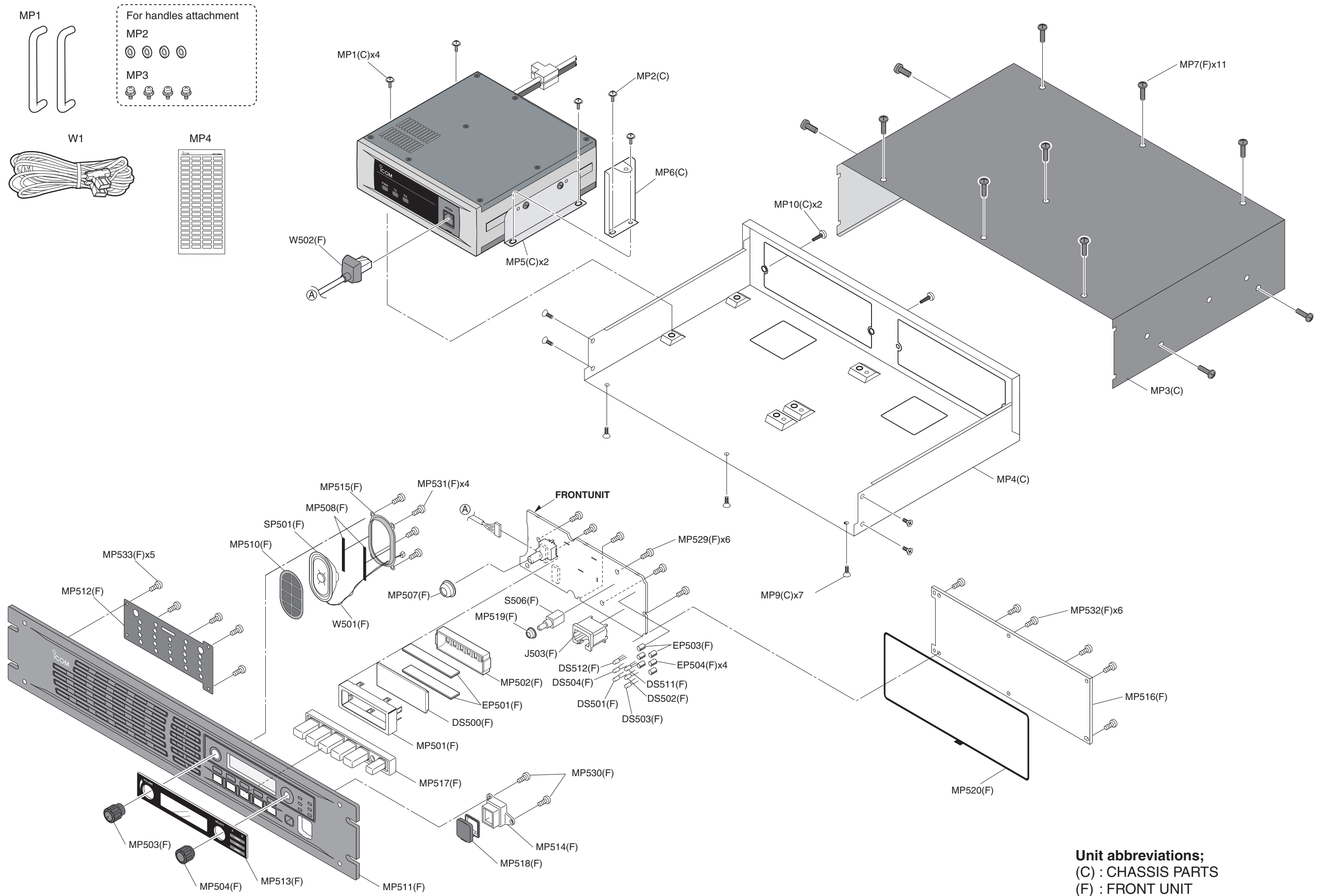

Unit abbreviations;
 (C) : CHASSIS PARTS
 (F) : FRONT UNIT
 (M) : MAIN UNIT
 (CN) : CONNECTOR UNIT

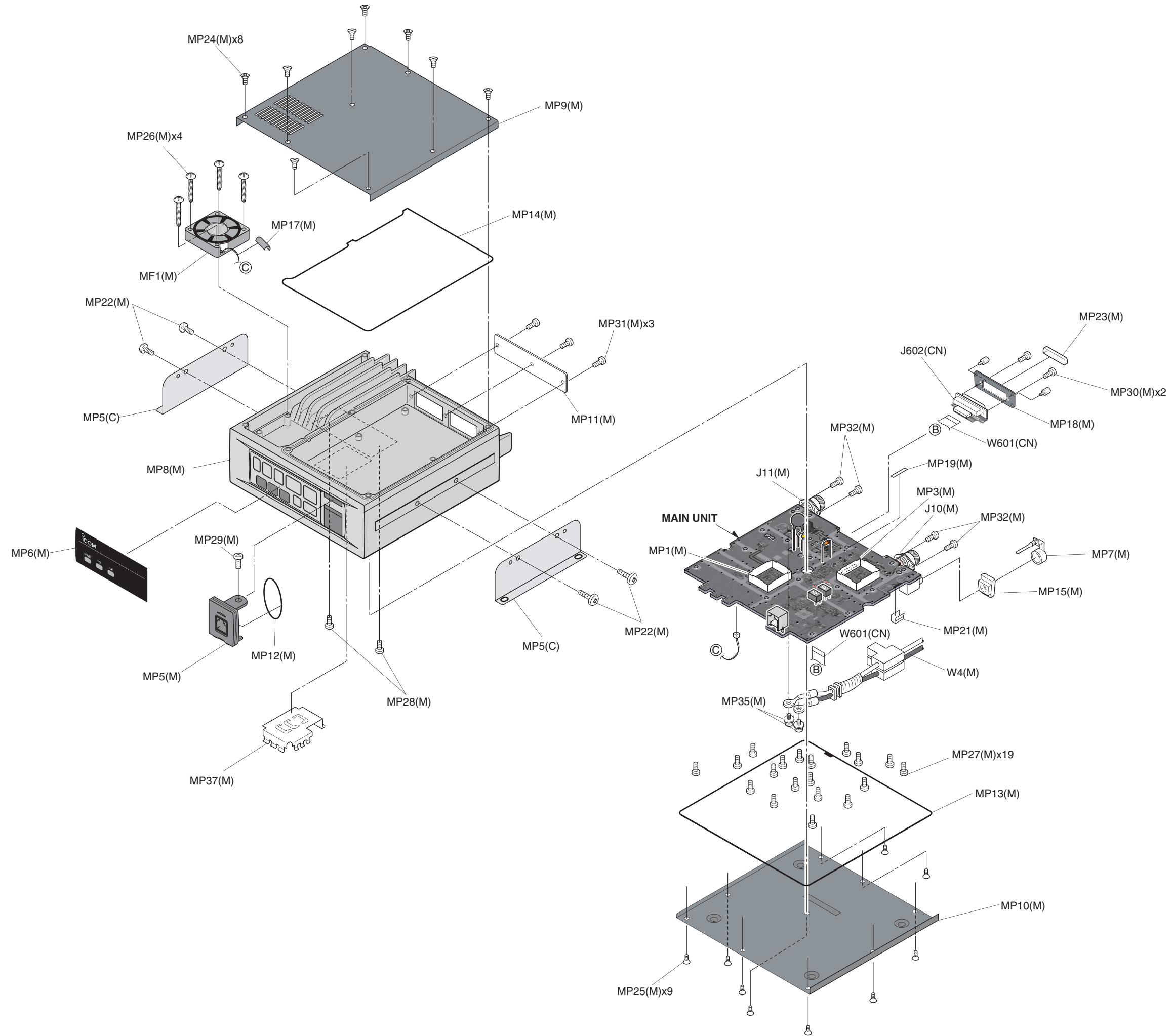

Unit abbreviations;
 (C) : CHASSIS PARTS
 (F) : FRONT UNIT
 (M) : MAIN UNIT
 (CN) : CONNECTOR UNIT

SECTION 9

BOARD LAYOUTS

• MAIN UNIT (TOP VIEW)

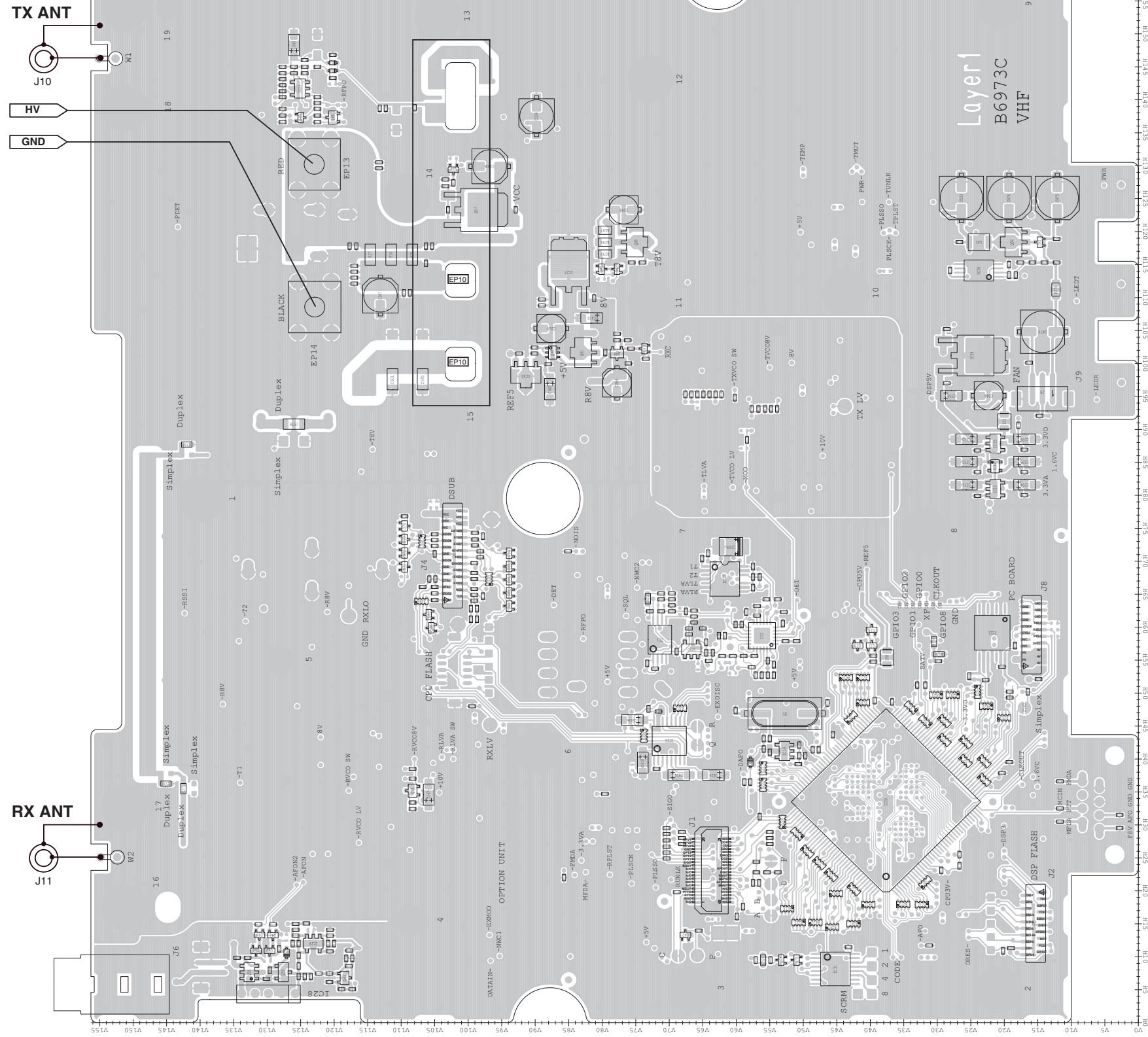

• FRONT UNIT (TOP VIEW)

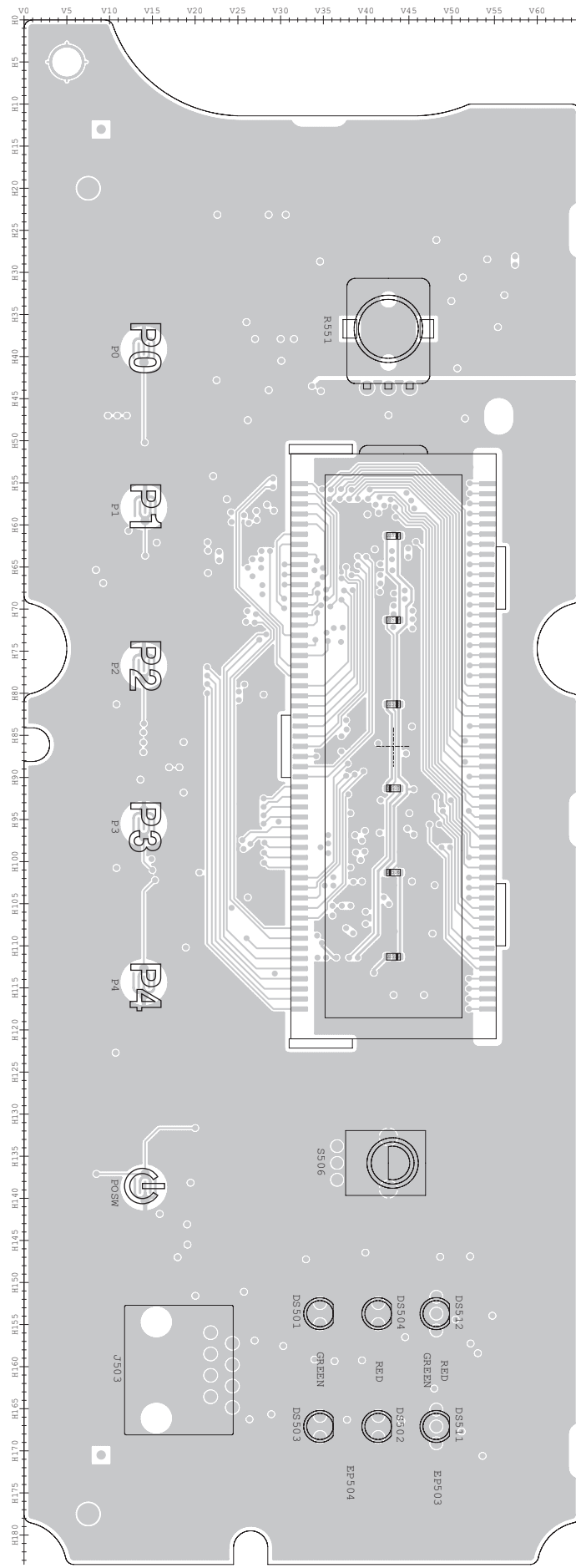

• CONNECT UNIT (TOP VIEW)

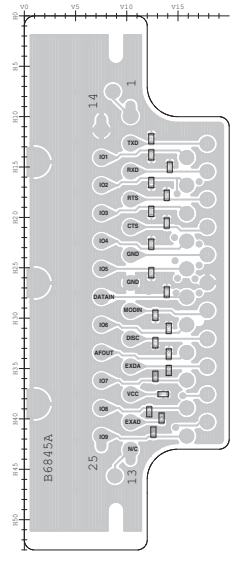

SECTION 10

BLOCK DIAGRAM

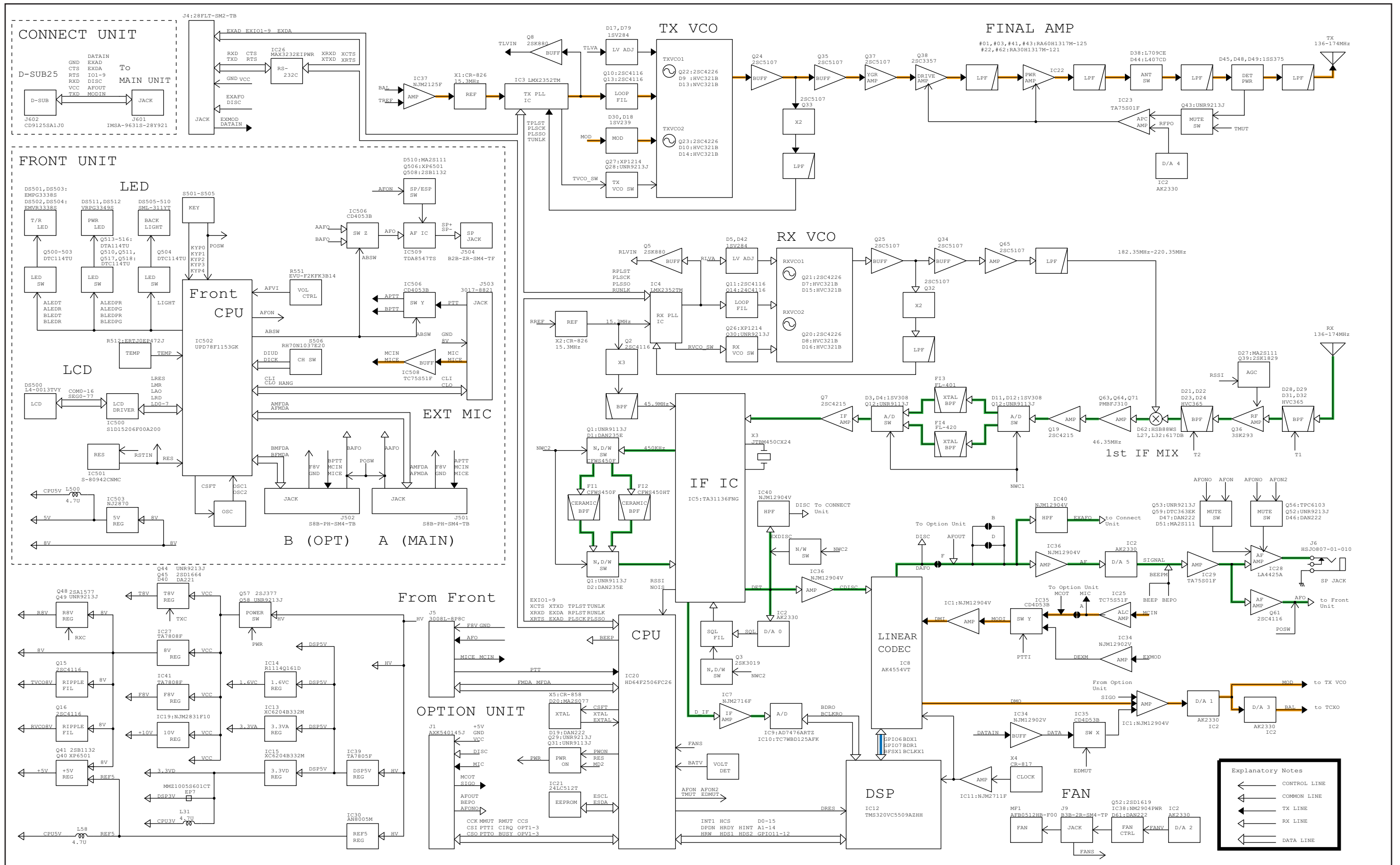

FRONT UNIT

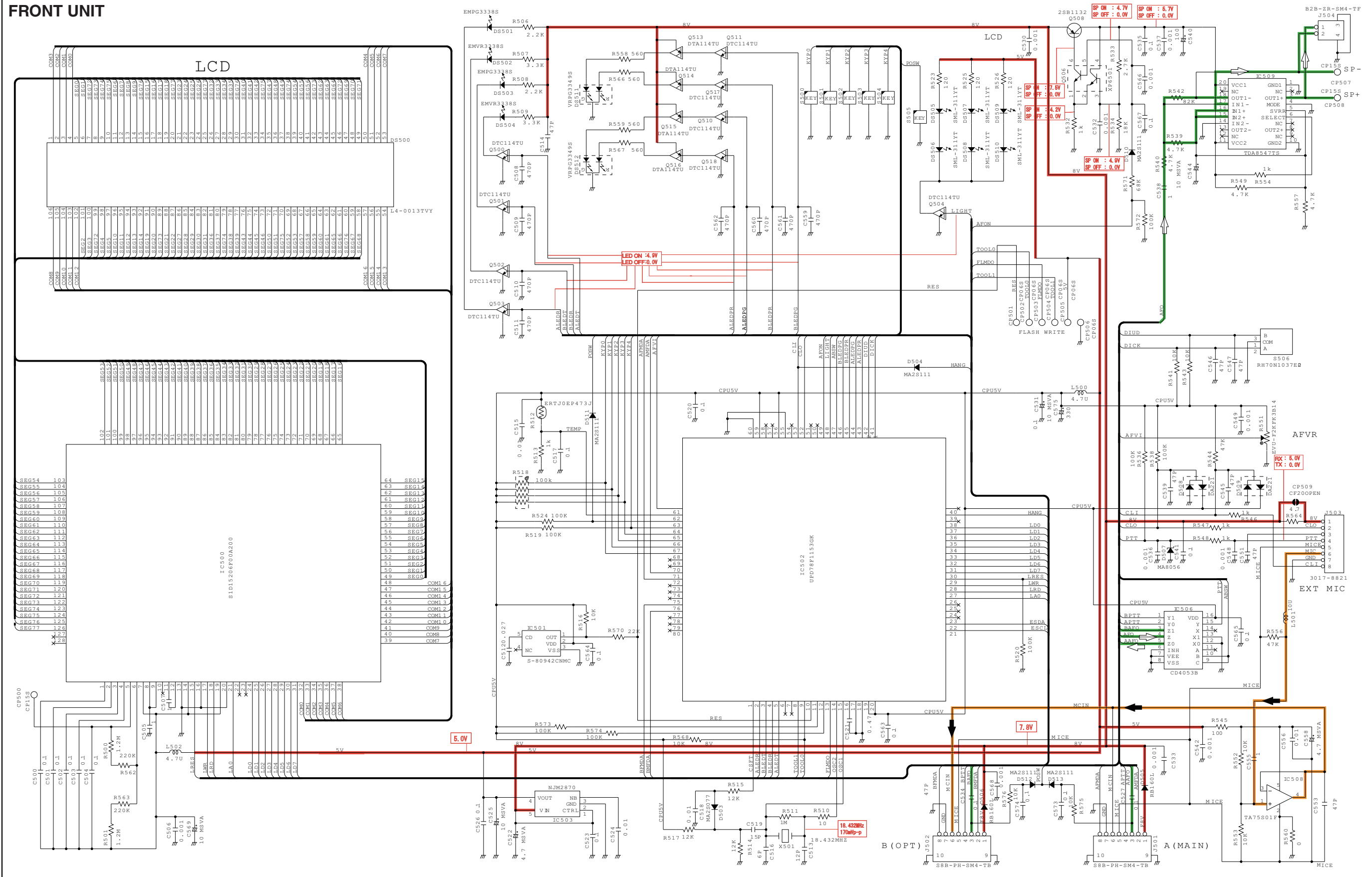

*; Refer to "PARTS LIST"

MAIN UNIT (1/3)

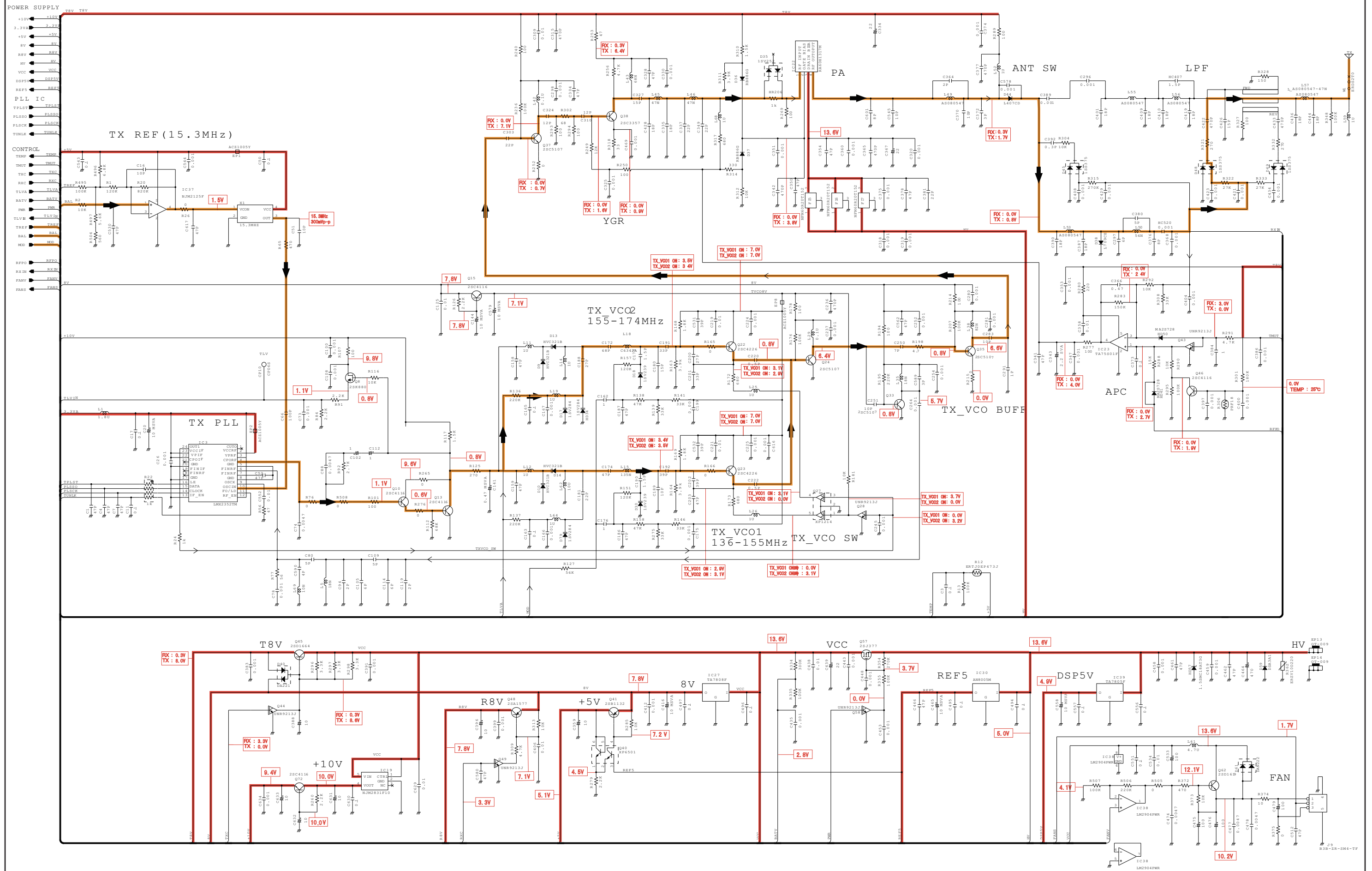

*; Refer to "PARTS LIST."

MAIN UNIT (2/3)

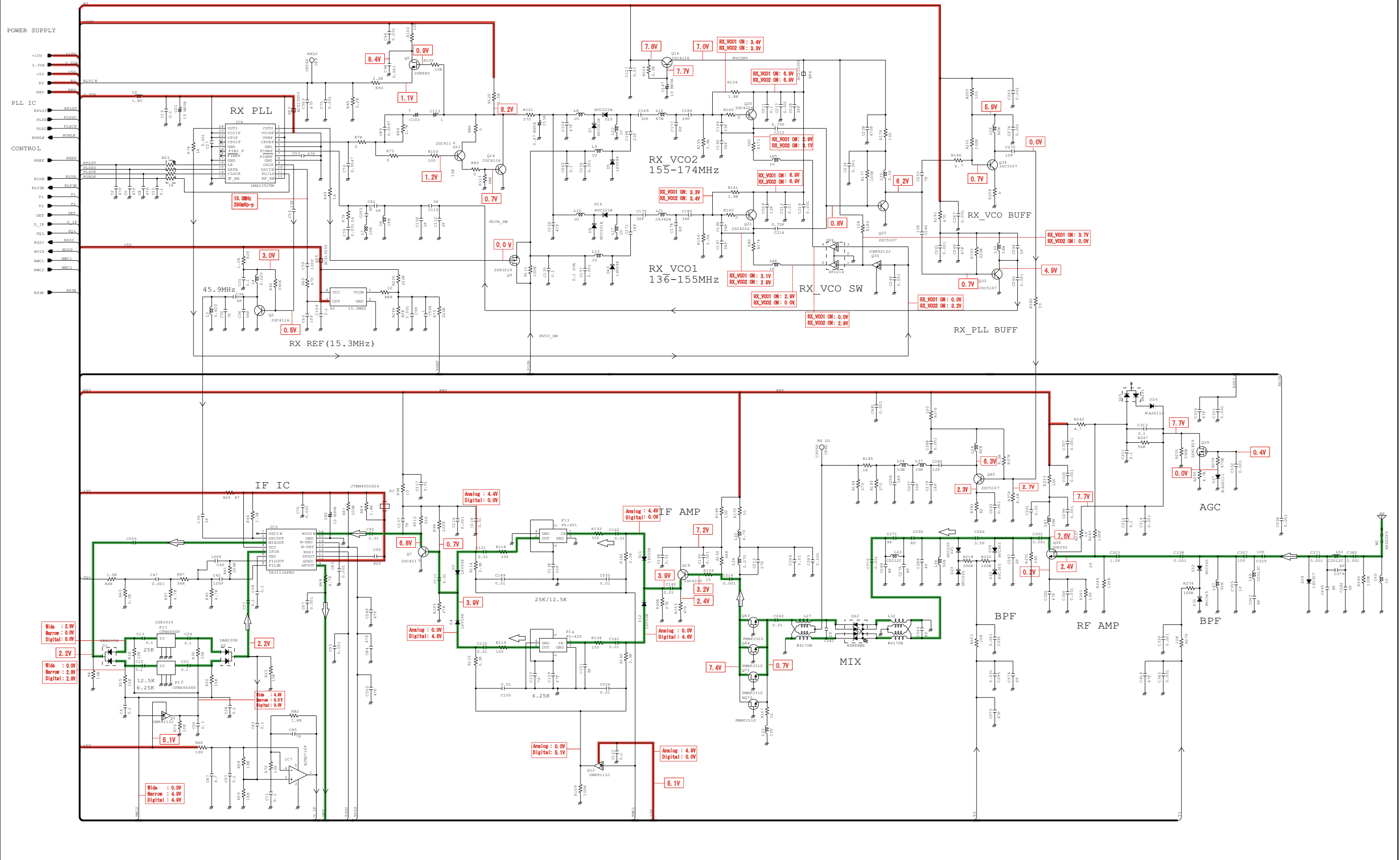

*; Refer to "PARTS LIST"

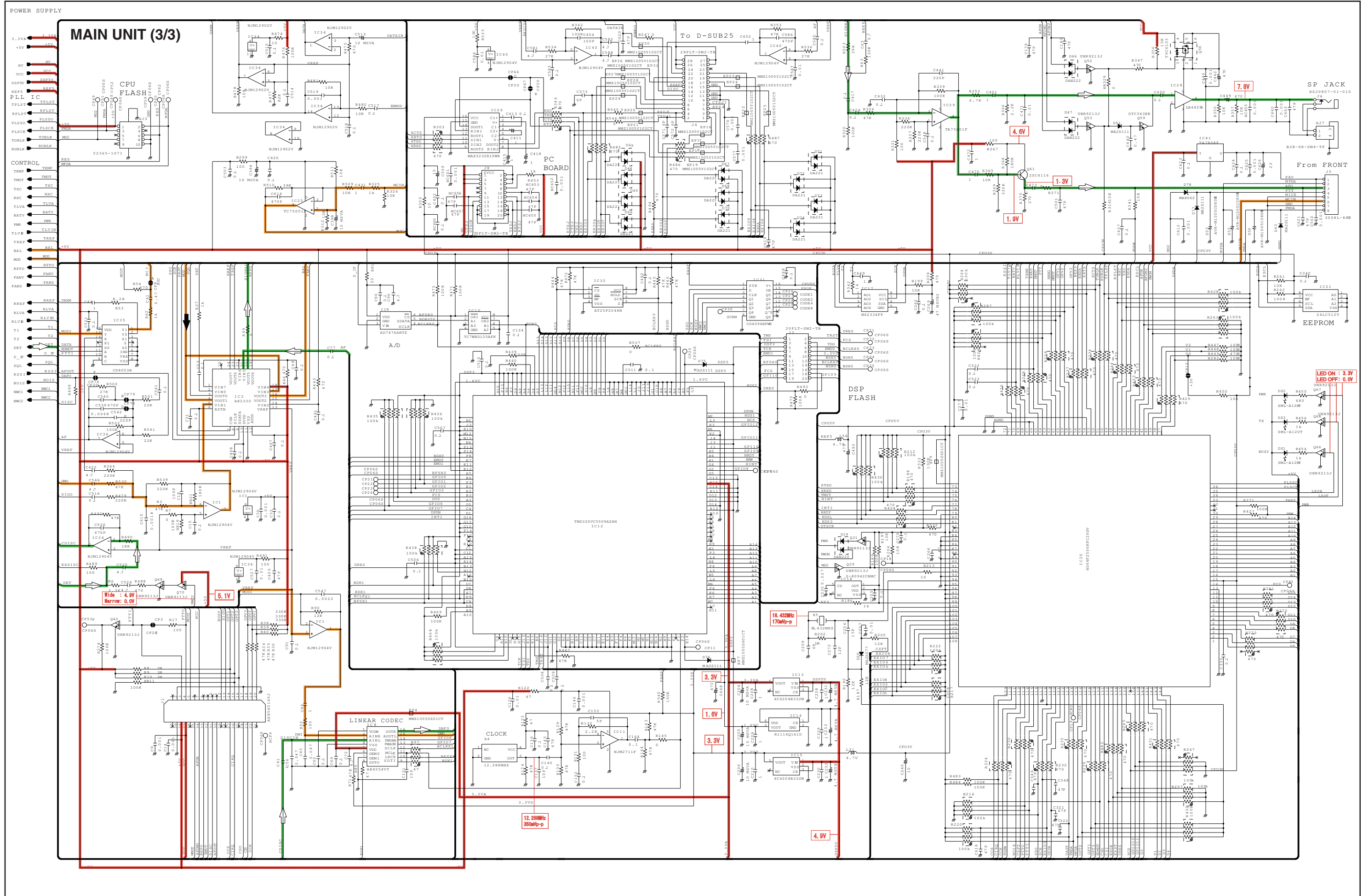

*; Refer to "PARTS LIST"

• ACCESSORY CONNECTOR (CONNECT UNIT) INFORMATION

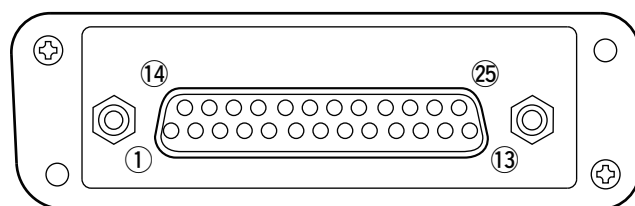
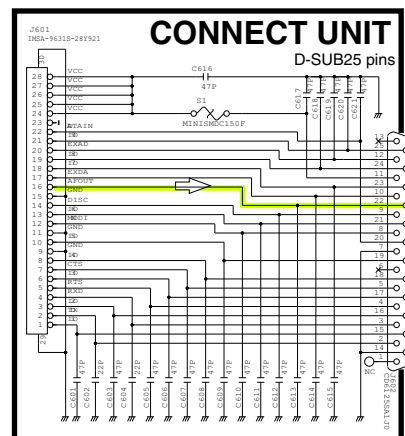

Pin No.	Pin Name	Description	Specification
1	NC	No connection	—
2	TXD	Output terminal for serial communication data.	—
3	RXD	Input terminal for serial communication data.	—
4	RTS	Output terminal for request-to-send data.	—
5	CTS	Input terminal for clear-to-send data.	—
6	NC	No connection	—
7	GND	Serial/digital signal ground	—
8	MOD IN	Modulator input from an external terminal unit.	Input level: 300 mV rms
9	DISC OUT	Output terminal for AF signals from the AF detector circuit. Output level is fixed, regardless of [AF] control.	Output level: 300 mV rms
10	EXT. D/A	The desired function can be assigned.* (Default: Null)	—
11	VCC	13.6 V DC output	Output current: Less than 1 A
12	EXT. A/D	Customize A/D input (Not used)	—
13	NC	No connection	—
14	GND	Ground	—
15	EXT./O 15	The desired function can be assigned.* (Default: Null)	+5 V pull up, Active=L
16	EXT./O 16	The desired function can be assigned.* (Default: P0 Monitor Output)	+5 V pull up, Active=L
17	EXT./O 17	The desired function can be assigned.* (Default: Busy Output)	+5 V pull up, Active=L
18	EXT./O 18	The desired function can be assigned.* (Default: Null)	+5 V pull up, Active=L
19	EXT./O 19	The desired function can be assigned.* (Default: EPTT Input)	+5 V pull up, Active=L
20	DATA IN	Input terminal for data.	—
21	EXT./O 21	The desired function can be assigned.* (Default: Analog Audible Output)	+5 V pull up, Active=L
22	AF OUT	The AF detector Output.	—
23	EXT./O 23	The desired function can be assigned.* (Default: Mic Mute Output)	+5 V pull up, Active=L
24	EXT./O 24	The desired function can be assigned.* (Default: Null)	+5 V pull up, Active=L
25	EXT./O 25	The desired function can be assigned.* (Default: Mic Hanger Output)	+5 V pull up, Active=L

* The desired function can be assigned using the optional CS-FR5000 CLONING SOFTWARE. Ask your dealer for details.

Icom Inc.

1-1-32, Kamiminami, Hirano-ku, Osaka 547-0003, Japan
Phone : +81 (06) 6793 5302
Fax : +81 (06) 6793 0013
URL : <http://www.icom.co.jp/world/index.html>

Icom America Inc.

<Corporate Headquarters>
2380 116th Avenue N.E., Bellevue, WA 98004, U.S.A.
Phone : +1 (425) 454-8155 Fax : +1 (425) 454-1509
URL : <http://www.icomamerica.com>
E-mail : sales@icomamerica.com
<Customer Service>
Phone : +1 (425) 454-7619

Icom Canada

Glenwood Centre #150-6165
Highway 17 Delta, B.C., V4K 5B8, Canada
Phone : +1 (604) 952-4266 Fax : +1 (604) 952-0090
URL : <http://www.icomcanada.com>
E-mail : info@icomcanada.com

Icom (Australia) Pty. Ltd.

Unit 1 / 103 Garden Road, Clayton VIC 3168 Australia
Phone : +61 (03) 9549-7500 Fax : +61 (03) 9549-7505
URL : <http://www.icom.net.au>
E-mail : sales@icom.net.au

Icom New Zealand

146A Harris Road, East Tamaki,
Auckland, New Zealand
Phone : +64 (09) 274 4062 Fax : +64 (09) 274 4708
URL : <http://www.icom.co.nz>
E-mail : inquiries@icom.co.nz

Beijing Icom Ltd.

10C07, Long silver Mansion, No.88, Yong Ding
Road, Haidian District, Beijing, 100039, China
Phone : +86 (010) 5889 5391/5392/5393
Fax : +86 (010) 5889 5395
E-mail : bjicom@bjicom.com
URL : <http://www.bjicom.com>

Icom (Europe) GmbH

Communication Equipment
Auf der Krautweide 24
65812 Bad Soden am Taunus, Germany
Phone : +49 (6196) 76685-0 Fax : +49 (6196) 76685-50
URL : <http://www.icomeurope.com>
E-mail : info@icomeurope.com

Icom Spain S.L

Ctra. Rubi, No. 88 Bajos A 08174, Sant Cugat del Valles, Barcelona, Spain
Phone : +34 (93) 590 26 70 Fax : +34 (93) 589 04 46
URL : <http://www.icomspain.com>
E-mail : icom@icomspain.com

Icom (UK) Ltd.

Blacksole House, The Boulevard, Altira Business Park, Herne Bay, CT6 6GZ, UK
Phone : +44 (01227) 741741 Fax : +44 (01227) 741742
URL : <http://www.icomuk.co.uk>
E-mail : info@icomuk.co.uk

Icom France s.a.s.

Zac de la Plaine
1 Rue Brindejone des Moulinais BP 5804
31505 Toulouse Cedex, France
Phone : +33 (5) 61 36 03 03 Fax : +33 (5) 61 36 03 00
URL : <http://www.icom-france.com>
E-mail : icom@icom-france.com

Asia Icom Inc.

6F No.68, Sec. 1 Cheng-Teh Road, Taipei, Taiwan, R.O.C.
Phone : +886 (02) 2559 1899 Fax : +886 (02) 2559 1874
URL : <http://www.asia-icom.com>
E-mail : sales@asia-icom.com

Icom Polska

81-850 Sopot, ul. 3 Maja 54, Poland
Phone : +48 (58) 550 7135 Fax : +48 (58) 551 0484
E-mail : icompolska@icompolska.com.pl

Count on us!

Icom Inc.

1-1-32, Kamiminami, Hirano-ku, Osaka 547-0003, Japan

S-14425XZ-C1
© 2008 Icom Inc.